

Panasonic

ideas for life

NARROW-PITCH CONNECTORS FOR BOARD-TO-FPC CONNECTION

NARROW PITCH (0.4mm) CONNECTORS F4

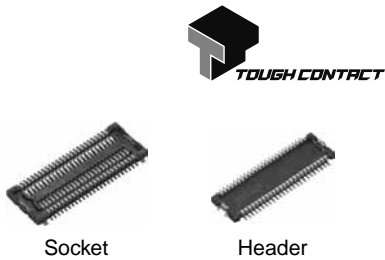

Compliance with RoHS Directive

2. Strong resistance to adverse environments! Utilizes *TOUGH CONTACT* construction for high contact reliability.
(See Page 6 for details of the structure)

3. Improved mating strength between the socket and header
The simple locking structures provided for the soldering terminals and the contact points improve the mating strength and provide tactile feedback when locked.

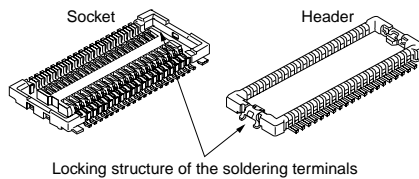

4. Easy to design product circuits
1) An insulating wall provided for the bottom surface of the connector prevents contact between the pattern on the PC board and the metal pins, enabling pattern wiring under the connector, and thus contributing to the reduction in size of PC boards.

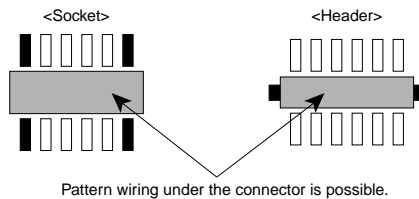

5. Connectors for inspection available
Connectors for inspection are available that are ideal for modular unit inspection and inspection in device assembly processes.

APPLICATIONS

Compact portable devices “Cellular phones, DVD, DSC, etc”

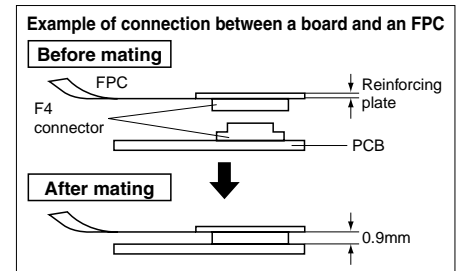

FEATURES

1. The lowest profile class among two-piece connectors in the world (Mated height: 0.9mm)

Achieved both a 0.4 mm pitch and an ultra low profile of 0.9 mm high when mated, contributing to further thickness reduction of products.

AXK7L, 8L

ORDERING INFORMATION

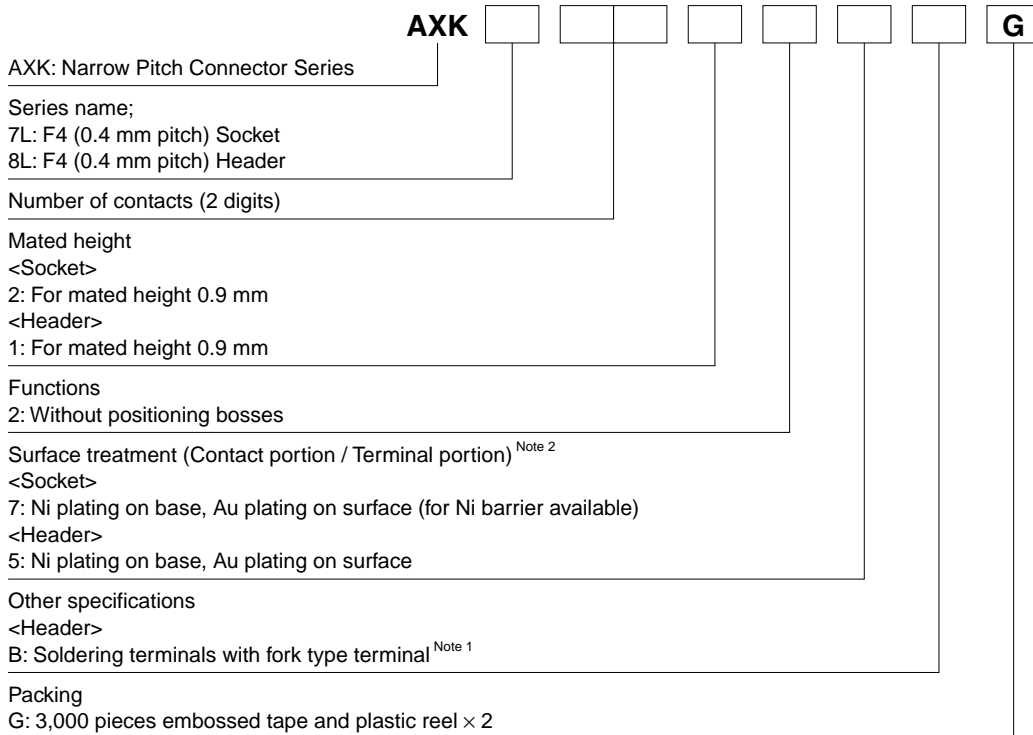

- Notes: 1. "B" in the 11th digit of the header part number signifies a fork type soldering terminals to lessen the constraint on amount of solder when mounting, and a construction that makes it difficult when mounting for excess solder to interfere with the socket.
Although compatible with the previous parts, these parts are not compatible with the recommended PC board pattern and recommended metal mask pattern.
2. The part number will be changed as follows due to the change in the plating specifications for the metal clips.
This change will apply to production from December 2009 onwards. (There will be no change to the contact portion and terminal portion.)
(Socket)
3: Ni plating on base, Au plating on surface (for Ni barrier available)
(Header)
4: Ni plating on base, Au plating on surface

PRODUCT TYPES 

Mated height	Number of contacts	Part number				Packing	
		Socket	Socket Products with plating change to soldering terminals (in effect from Dec. '09)	Header	Header Products with plating change to soldering terminals (in effect from Dec. '09)	Inner carton (1 reel)	Outer carton
0.9 mm	10	AXK7L10227G	AXK7L10223G	AXK8L10125BG	AXK8L10124BG	3,000 pieces	6,000 pieces (2 reels)
	12	AXK7L12227G	AXK7L12223G	AXK8L12125BG	AXK8L12124BG		
	14	AXK7L14227G	AXK7L14223G	AXK8L14125BG	AXK8L14124BG		
	16	AXK7L16227G	AXK7L16223G	AXK8L16125BG	AXK8L16124BG		
	20	AXK7L20227G	AXK7L20223G	AXK8L20125BG	AXK8L20124BG		
	22	AXK7L22227G	AXK7L22223G	AXK8L22125BG	AXK8L22124BG		
	24	AXK7L24227G	AXK7L24223G	AXK8L24125BG	AXK8L24124BG		
	26	AXK7L26227G	AXK7L26223G	AXK8L26125BG	AXK8L26124BG		
	28	AXK7L28227G	AXK7L28223G	AXK8L28125BG	AXK8L28124BG		
	30	AXK7L30227G	AXK7L30223G	AXK8L30125BG	AXK8L30124BG		
	32	AXK7L32227G	AXK7L32223G	AXK8L32125BG	AXK8L32124BG		
	34	AXK7L34227G	AXK7L34223G	AXK8L34125BG	AXK8L34124BG		
	36	AXK7L36227G	AXK7L36223G	AXK8L36125BG	AXK8L36124BG		
	38	AXK7L38227G	AXK7L38223G	AXK8L38125BG	AXK8L38124BG		
	40	AXK7L40227G	AXK7L40223G	AXK8L40125BG	AXK8L40124BG		
	44	AXK7L44227G	AXK7L44223G	AXK8L44125BG	AXK8L44124BG		
	48	AXK7L48227G	AXK7L48223G	AXK8L48125BG	AXK8L48124BG		
50	AXK7L50227G	AXK7L50223G	AXK8L50125BG	AXK8L50124BG			
54	AXK7L54227G	AXK7L54223G	AXK8L54125BG	AXK8L54124BG			
60	AXK7L60227G	AXK7L60223G	AXK8L60125BG	AXK8L60124BG			
66	AXK7L66227G	AXK7L66223G	AXK8L66125BG	AXK8L66124BG			
70	AXK7L70227G	AXK7L70223G	AXK8L70125BG	AXK8L70124BG			
80	AXK7L80227G	AXK7L80223G	AXK8L80125BG	AXK8L80124BG			

- Notes: 1. Regarding ordering units;
 During production: Please make orders in 1-reel units.
 Samples for mounting confirmation: Available in units of 50 pieces. Please contact us.
 Samples: Available. Please contact us.
2. The above part numbers are for connectors without positioning bosses, which are standard. When ordering connectors with positioning bosses, please contact our sales office.
3. Please contact us regarding different number of contacts.
4. "B" in the 11th digit of the header part number signifies a fork type soldering terminals to lessen the constraint on amount of solder when mounting, and a construction that makes it difficult when mounting for excess solder to interfere with the socket.
 Although compatible with the previous parts, these parts are not compatible with the recommended PC board pattern and recommended metal mask pattern.
5. Since the plating specifications for the metal clips will be changed starting with production in December 2009 onwards, the digit "7" in the 10th place of the part number for sockets will be changed to "3", and "5" for headers will be changed to "4".
 Be careful when placing an order.

SPECIFICATIONS

1. Characteristics

	Item	Specifications	Conditions
Electrical characteristics	Rated current	0.3A/terminal (Max. 5 A at total terminals)	—
	Rated voltage	60V AC/DC	—
	Breakdown voltage	150V AC for 1 min.	Rated voltage is applied for one minute and check for short circuit or damage with a detection current of 1mA
	Insulation resistance	Min. 1,000MΩ (Initial)	Using 250V DC megger (applied for 1 min.)
	Contact resistance	Max. 90mΩ	Based on the contact resistance measurement method specified by JIS C 5402.
Environmental characteristics	Ambient temperature	-55°C to +85°C	No freezing at low temperatures
	Soldering heat resistance	Max. peak temperature of 260°C (on the surface of the PC board around the connector terminals)	Infrared reflow soldering
		300°C within 5 sec, 350°C within 3 sec.	Soldering iron
	Storage temperature	-55°C to +85°C (Product only) -40°C to +50°C (Emboss packing)	No freezing at low temperatures
	Thermal shock resistance (header and socket mated)	5 cycles, insulation resistance min. 100MΩ, contact resistance max. 90mΩ	Sequence 1. -55 [±] 3°C, 30 min. 2. ~, Max. 5 min. 3. 85 [±] 3°C, 30 min. 4. ~, Max. 5 min.
	Humidity resistance (header and socket mated)	120 hours, insulation resistance min. 100MΩ, contact resistance max. 90mΩ	Temperature 40±2°C, humidity 90 to 95% R.H.
	Saltwater spray resistance (header and socket mated)	24 hours, insulation resistance min. 100MΩ, contact resistance max. 90mΩ	Temperature 35±2°C, saltwater concentration 5±1%
H ₂ S resistance (header and socket mated)	48 hours, contact resistance max. 90mΩ	Temperature 40±2°C, gas concentration 3±1 ppm, humidity 75 to 80% R.H.	
Lifetime characteristics	Insertion and removal life	50 times	Repeated insertion and removal speed of max. 200 times/hours
Unit weight		20 contacts; Socket: 0.03g Header: 0.01g	—

AXK7L, 8L

2. Material and surface treatment

Part name	Material	Surface treatment
Molded portion	LCP resin (UL94V-0)	—
Contact/Post	Copper alloy	Contact portion: Ni plating on base, Au plating on surface Terminal portion: Ni plating on base, Au plating on surface (Except for front edge of terminal) However, the area adjacent to the socket terminal is exposed to Ni on base. Metal clips ^{Note)} : Ni plating on base, Sn plating on surface (Socket: except for front edge of the terminal)

Note: The following change will apply to production from December 2009 onwards.

Socket: Ni plating on base, Pd + Au flash plating on surface (Expect for front edge of terminal)

Header: Ni plating on base, Au plating on surface (Expect for front edge of terminal)

DIMENSIONS (unit: mm)

The CAD data of the products with a **CAD Data** mark can be downloaded from: <http://panasonic-electric-works.net/ac>

• Socket (Mated height 0.9 mm)

CAD Data

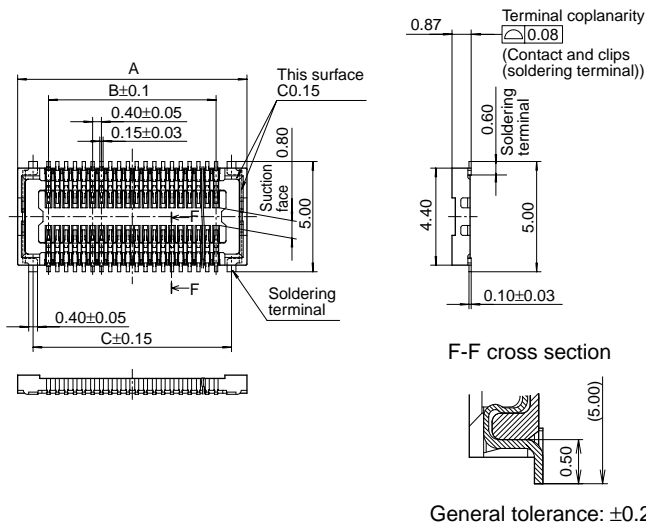

General tolerance: ±0.2

Dimension table (mm)

Number of contacts/ Dimensions	A	B	C
10	4.4	1.6	3.0
12	4.8	2.0	3.4
14	5.2	2.4	3.8
16	5.6	2.8	4.2
20	6.4	3.6	5.0
22	6.8	4.0	5.4
24	7.2	4.4	5.8
26	7.6	4.8	6.2
28	8.0	5.2	6.6
30	8.4	5.6	7.0
32	8.8	6.0	7.4
34	9.2	6.4	7.8
36	9.6	6.8	8.2
38	10.0	7.2	8.6
40	10.4	7.6	9.0
44	11.2	8.4	9.8
48	12.0	9.2	10.6
50	12.4	9.6	11.0
54	13.2	10.4	11.8
60	14.4	11.6	13.0
66	15.6	12.8	14.2
70	16.4	13.6	15.0
80	18.4	15.6	17.0

• Header (Mated height: 0.9 mm)

CAD Data

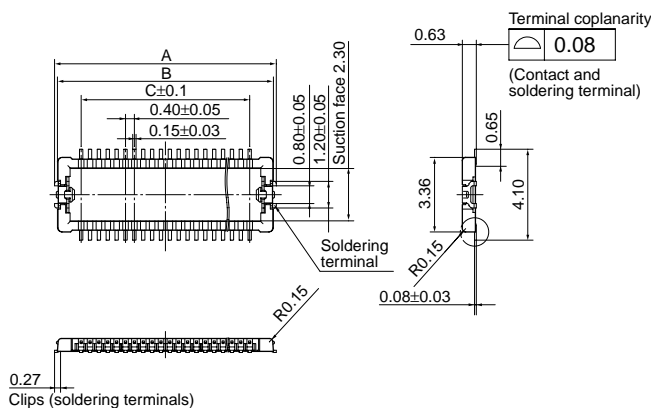

General tolerance: ±0.2

Dimension table (mm)

Number of contacts/ Dimensions	A	B	C
10	4.0	3.74	1.6
12	4.4	4.14	2.0
14	4.8	4.54	2.4
16	5.2	4.94	2.8
20	6.0	5.74	3.6
22	6.4	6.14	4.0
24	6.8	6.54	4.4
26	7.2	6.94	4.8
28	7.6	7.34	5.2
30	8.0	7.74	5.6
32	8.4	8.14	6.0
34	8.8	8.54	6.4
36	9.2	8.94	6.8
38	9.6	9.34	7.2
40	10.0	9.74	7.6
44	10.8	10.54	8.4
48	11.6	11.34	9.2
50	12.0	11.74	9.6
54	12.8	12.54	10.4
60	14.0	13.74	11.6
66	15.2	14.94	12.8
70	16.0	15.74	13.6
80	18.0	17.74	15.6

• Socket and header are mated

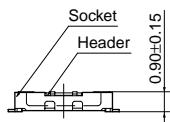

EMBOSSED TAPE DIMENSIONS (unit: mm) (Common for respective contact type, socket and header)

Tape dimensions (Conforming to JIS C 0806-1990. However, some tapes have mounting hole pitches that do not comply with the standard.)

Plastic reel dimensions (Conforming to EIAJ ET-7200B)

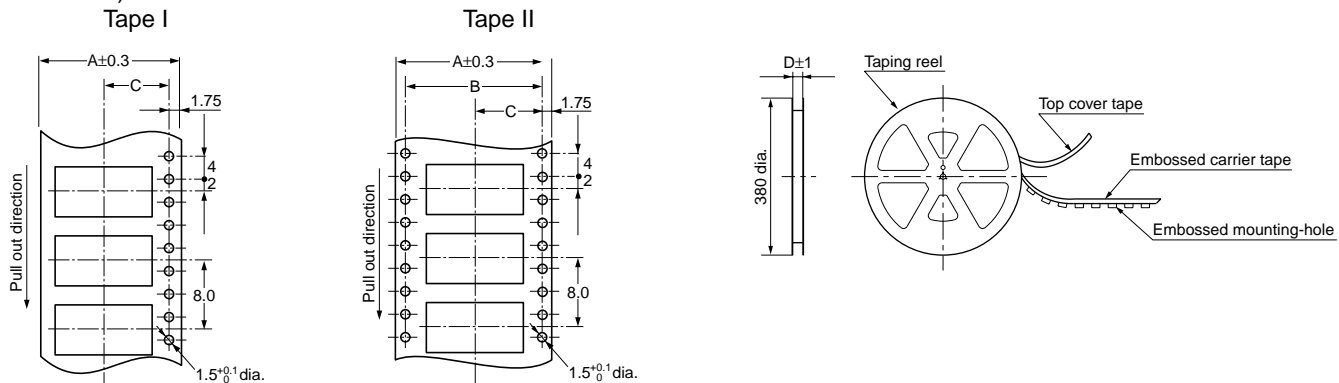
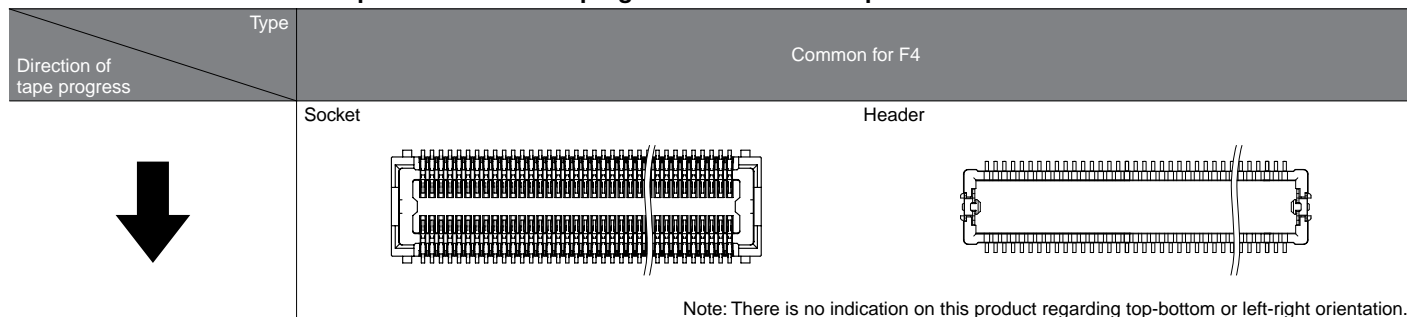

TABLE OF DIMENSIONS

Mated height	Number of contacts	Type of taping	A	B	C	D	Quantity per reel
Common for socket and header: 0.9mm	Max. 24	Tape I	16.0	—	7.5	17.4	3000
	26 to 70	Tape I	24.0	—	11.5	25.4	3000
	80	Tape II	32.0	28.4	14.2	33.4	3000

Connector orientation with respect to direction of progress of embossed tape



Note: There is no indication on this product regarding top-bottom or left-right orientation.



Socket



Header

Compliance with RoHS Directive

FEATURES

- 1. 3,000 insertion and removals (when as recommended)**
- 2. Same external dimensions and foot pattern as standard type.**
- 3. Improved mating**

Insertion and removal have become easier due to a reduction in the mating retention force required by the simple locking structure and also in the amount of force needed for insertion and removal. (We cannot warrant anything regarding mating retention.)

APPLICATIONS

Ideal for module unit inspection and equipment assembly inspection

TABLE OF PRODUCT TYPES

☆: Available for sale

Product name	Number of contacts																						
F4 for inspection	10	12	14	16	20	22	24	26	28	30	32	34	36	38	40	44	48	50	54	60	66	70	80
	☆	☆	☆	☆	☆	☆	☆	☆	☆	☆	☆	☆	☆	☆	☆	☆	☆	☆	☆	☆	☆	☆	☆

- Notes: 1. Please inquire about numbers of contacts other than those given above.
 2. Please inquire with us regarding delivery times.
 3. Please keep the minimum unit for ordering no less than 50 pieces per lot.
 4. Please inquire for further information.

PRODUCT TYPES

Specifications		Part No.	Specifications		Part No.
Socket	Without positioning bosses	AXK7LE**26G	Header	Without positioning bosses	AXK8LE**26BG

- Notes: 1. When placing an order, substitute the "*" (asterisk) in the above part number with the number of contacts for the required connector.
 2. The above part numbers are for connectors without positioning bosses, which are standard. When ordering connectors with positioning bosses, please contact our sales office.

NOTES

1. Removal by pulling up from an end causes the entire connector removal force to concentrate on the soldering terminals and end terminals.

Therefore, please lift and remove from the side. Doing so will also prevent cracking of the soldered parts.

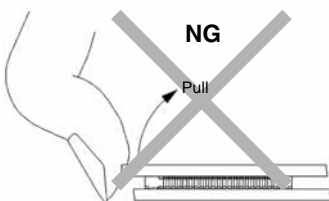
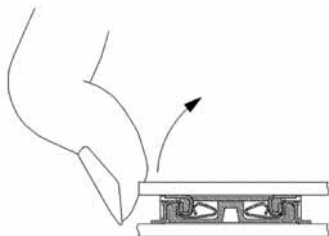

2. PC Boards and Recommended Metal Mask Patterns

Connectors are mounted with high density, with a pitch interval of 0.4 to 0.5 mm.

In order to reduce solder bridge and other issues make sure the proper levels of solder are used.

The figures to the right are recommended metal mask patterns. Please use them as a reference.

In particular, if a lot of solder is used in the header retaining soldering terminals, it might interfere with and cause incomplete socket mating. Therefore, please follow the recommended conditions give on the right.

Socket

Recommended PC board pattern
(Mount pad arrangement pattern)

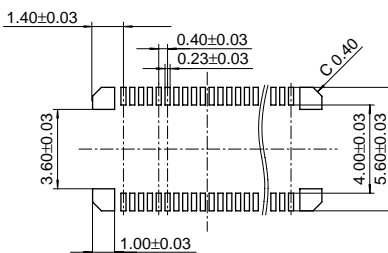

Recommended metal mask pattern

Metal mask thickness: Here, 150 μm
(Terminal portion opening area ratio: 53 %)
(Metal portion opening area ratio: 100 %)

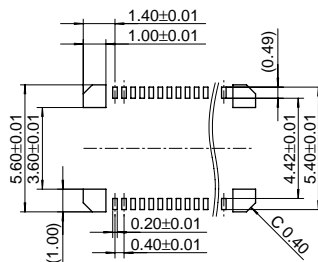

Recommended metal mask pattern

Metal mask thickness: Here, 120 μm
(Terminal portion opening area ratio: 66 %)
(Metal portion opening area ratio: 100 %)

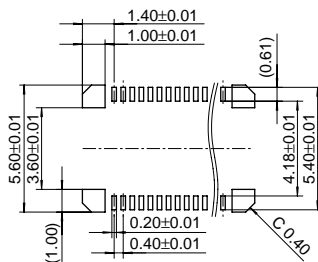

Header

Recommended PC board pattern
(Mount pad arrangement pattern)

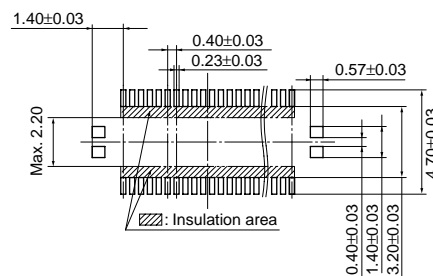

Relation between connector and mounting pad

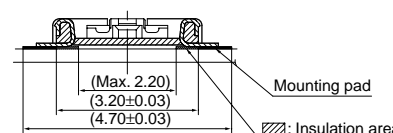

Recommended metal mask pattern

Metal mask thickness: Here, 150 μm
(Terminal portion opening area ratio: 52 %)
(Metal portion opening area ratio: 80 %)

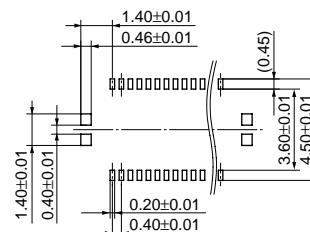

Recommended metal mask pattern

Metal mask thickness: Here, 120 μm
(Terminal portion opening area ratio: 66 %)
(Metal portion opening area ratio: 100 %)

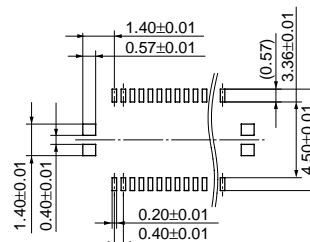

For other details, please verify with the product specification sheets.