

Low Signal Relay G6A

Fully Sealed Relay with High Impulse Withstand

- High sensitivity — can be driven by digital circuits.
- Low-profile design allows use in 12.70 mm PC board rack.
- Surge withstand voltage meets FCC Part 68 regulation.
- Units can be mounted side by side due to low magnetic leakage.
- Special models available for low thermoelectromotive force.
- Unique moving loop (permanent magnet) armature reduces relay size, magnetic interference, and contact bounce time.
- Single or dual coil winding types available.
- RoHS Compliant

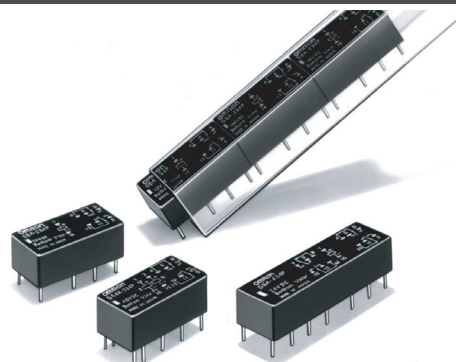

Ordering Information

To Order: Select the part number and add the desired coil voltage rating, (e.g., G6A-274P-ST-US-DC12).

■ Non-latching

Type	Contact form	Model
		Ag (Au clad)
Standard	DPDT	G6A-274P-ST-US
	4PDT - DISCONTINUED	G6A-474P-ST-US
Low-sensitivity	DPDT	G6A-274P-ST40-US
	4PDT - DISCONTINUED	G6A-474P-ST40-US

■ Latching

Single Coil

Type	Contact form	Model
		Ag (Au clad)
Standard	DPDT	G6AU-274P-ST-US
	4PDT - DISCONTINUED	G6AU-474P-ST-US

Dual Coil

Type	Contact form	Model
		Ag (Au clad)
Standard	DPDT	G6AK-274P-ST-US
	4PDT - DISCONTINUED	G6AK-474P-ST-US
Low-sensitivity	DPDT	G6AK-274P-ST40-US
	4PDT - DISCONTINUED	G6AK-474P-ST40-US

Specifications

■ Contact Data

Type	G6A-274P-ST(40)-US, G6A-474P-ST(40)-US G6AK-274P-ST(40)-US, G6AK-474P-ST(40)-US G6AU-274P-ST-US, G6AU-474P-ST-US	
Load	Resistive load (p.f. = 1)	Inductive load (p.f. = 0.4) (L/R = 7 ms)
Rated load	0.50 A at 125 VAC, 2 A at 30 VDC	0.3 A* at 125 VAC, 1 A at 30 VDC
Contact material	Ag (Au clad)	
Carry current	3 A	
Max. operating voltage	250 VAC, 220 VDC	
Max. operating current	2 A	1 A
Max. switching capacity	125 VA, 60 W	62.50 VA, 30 W
Min. permissible load (See note)	10 μA, 10 mVDC	

* 0.25A at 125VAC for latching models

Note: 1. P level: $\lambda_{60} = 0.1 \times 10^{-6}/\text{operation}$

This value was measured at a switching frequency of 60 operations/min and the criterion of contact resistance is 50 Ω. This value may vary depending on the switching frequency and operating environment. Always double-check relay suitability under actual operating conditions.

2. G6A-4 pole versions are discontinued.

■ Coil Data

Standard Non-latching DPDT (G6A-274P-ST-US)

Rated voltage (VDC)	Rated current (mA)	Coil resistance (Ω)	Coil inductance (ref. value) (H)		Pick-up voltage	Dropout voltage	Maximum voltage	Power consumption (mW)
			Armature OFF	Armature ON				
3	66.70	45	0.07	0.065	70% max.	10% min.	200% at 23°C	Approx. 200
4.5	44.6	101	0.16	0.14				
5	40	125	0.20	0.18				
6	33.30	180	0.29	0.26				
9	22.20	405	0.63	0.57				
12	16.70	720	1.10	1.06				
24	8.30	2,880	4.50	4.10				
48	4.90	9,750	13.70	12.50				

Low-sensitivity Non-latching DPDT (G6A-274P-ST40-US)

Rated voltage (VDC)	Rated current (mA)	Coil resistance (Ω)	Coil inductance (ref. value) (H)		Pick-up voltage	Dropout voltage	Maximum voltage	Power consumption (mW)
			Armature OFF	Armature ON				
3	133.30	22.50	0.03	0.02	70% max.	10% min.	150% at 23°C	Approx. 400
4.5	88.9	50.6	0.065	0.06				
5	80	62.50	0.08	0.07				
6	66.70	90	0.11	0.10				
9	44.30	203	0.27	0.23				
12	33.30	360	0.52	0.43				
24	16.70	1,440	2.10	1.80				
48	8.30	5,760	7.50	6.40				

Note: 1. The rated current and coil resistance are measured at a coil temperature of 23°C with a tolerance of ±10%.

2. Operating characteristics are measured at a coil temperature of 23°C.

3. The maximum voltage is the highest voltage that can be imposed on the relay coil.

Standard Non-latching 4PDT (G6A-474P-ST-US - DISCONTINUED)

Rated voltage (VDC)	Rated current (mA)	Coil resistance (Ω)	Coil inductance (ref. value) (H)		Pick-up voltage	Dropout voltage	Maximum voltage	Power consumption (mW)
			Armature OFF	Armature ON				
3	120	25	0.05	0.045	70% max.	10% min.	150% at 23°C	Approx. 360
4.5	79.9	56.3	0.11	0.095				
5	72.50	69	0.14	0.12				
6	60	100	0.20	0.17				
9	40	225	0.45	0.38				
12	30	400	0.80	0.68				
24	15	1,600	3.20	2.70				
48	7.50	6,400	12.80	10.90				

Low-sensitivity Non-latching 4PDT (G6A-474P-ST40-US - DISCONTINUED)

Rated voltage (VDC)	Rated current (mA)	Coil resistance (Ω)	Coil inductance (ref. value) (H)		Pick-up voltage	Dropout voltage	Maximum voltage	Power consumption (mW)
			Armature OFF	Armature ON				
3	133.30	22.50	0.035	0.02	70% max.	10% min.	150% at 23°C	Approx. 400
4.5	88.9	50.6	0.1	0.07				
5	80	62.50	0.12	0.09				
6	66.70	90	0.17	0.13				
9	44.30	203	0.42	0.30				
12	33.30	360	0.70	0.52				
24	16.70	1,440	2.80	2.20				
48	8.30	5,760	10.20	8.60				

Standard Single Coil Latching DPDT (G6AU-274P-ST-US)

Rated voltage (VDC)	Rated current (mA)	Coil resistance (Ω)	Coil inductance (ref. value) (H)		Set pick-up voltage	Reset pick-up voltage	Maximum voltage	Power consumption (mW)
			Armature OFF	Armature ON				
3	33.70	89	0.15	0.11	70% max.	70% min.	200% at 23°C	Approx. 100
4.5	22.2	202	0.34	0.25				
5	20	250	0.44	0.35				
6	16.70	360	0.64	0.48				
9	11.10	810	1.38	1.07				
12	8.30	1,440	2.50	2				
24	4.20	5,760	9.20	7.20				
48	2.50	19,000	28.50	22				Approx. 120

Standard Dual Coil Latching DPDT (G6AK-274P-ST-US)

Rated voltage (VDC)	Rated current (mA)	Coil resistance (Ω)	Coil inductance (ref. value) (H)				Set pick-up voltage	Reset pick-up voltage	Maximum voltage	Power consumption (mW)
			Set coil		Reset coil					
			Armature OFF	Armature ON	Armature OFF	Armature ON				
3	66.70	45	0.037	0.027	0.027	0.037	70% max.	70% min.	200% at 23°C	Approx. 200
4.5	40.2	112	0.09	0.065	0.065	0.09				
5	36	139	0.11	0.08	0.08	0.11				
6	30	200	0.16	0.12	0.12	0.16				
9	20	450	0.38	0.28	0.28	0.38				
12	15	800	0.60	0.45	0.45	0.60				
24	7.50	3,200	2.10	1.50	1.50	2.10				
48	4.20	11,520	8.50	6.30	6.30	8.50				Approx. 200

- Note:**
1. The rated current and coil resistance are measured at a coil temperature of 23°C with a tolerance of ±10%.
 2. Operating characteristics are measured at a coil temperature of 23°C.
 3. The maximum voltage is the highest voltage that can be imposed on the relay coil.

Low-sensitivity Dual Coil Latching DPDT (G6AK-274P-ST40-US)

Rated voltage (VDC)	Rated current (mA)	Coil resistance (Ω)	Coil inductance (ref. value) (H)				Set pick-up voltage	Reset pick-up voltage	Maximum voltage	Power consumption (mW)
			Set coil		Reset coil					
			Armature OFF	Armature ON	Armature OFF	Armature ON				
3	120	25	0.015	0.01	0.01	0.015	70% max.	70% min.	150% at 23°C	Approx. 360
4.5	79.9	56.3	0.04	0.025	0.025	0.04				
5	72.50	69	0.05	0.035	0.035	0.05				
6	60	100	0.07	0.05	0.05	0.07				
9	40	225	0.16	0.12	0.12	0.16				
12	30	400	0.28	0.20	0.20	0.28				
24	15	1,600	1.10	0.75	0.75	1.10				
48	7.50	6,400	4	2.90	2.9	4				

Standard Single Coil Latching 4PDT (G6AU-474P-ST-US - DISCONTINUED)

Rated voltage (VDC)	Rated current (mA)	Coil resistance (Ω)	Coil inductance (ref. value) (H)		Set pick-up voltage	Reset pick-up voltage	Maximum voltage	Power consumption (mW)
			Armature OFF	Armature ON				
3	106.80	28.10	0.03	0.02	70% max.	70% min.	150% at 23°C	Approx. 320
4.5	71.2	63.2	0.06	0.04				
5	64	78.10	0.08	0.06				
6	53.30	112.50	0.11	0.08				
9	35.60	253	0.25	0.18				
12	26.70	450	0.45	0.32				
24	13.30	1,800	1.80	1.30				
48	6.70	7,200	7.00	5.20				

Standard Dual Coil Latching 4PDT (G6AK-474P-ST-US - DISCONTINUED)

Rated voltage (VDC)	Rated current (mA)	Coil resistance (Ω)	Coil inductance (ref. value) (H)				Set pick-up voltage	Reset pick-up voltage	Maximum voltage	Power consumption (mW)
			Set coil		Reset coil					
			Armature OFF	Armature ON	Armature OFF	Armature ON				
3	106.80	28.10	0.03	0.02	0.02	0.03	70% max.	70% min.	150% at 23°C	Approx. 320
4.5	71.2	63.2	0.06	0.04	0.04	0.06				
5	64	78.10	0.08	0.06	0.06	0.08				
6	53.30	112.50	0.11	0.08	0.08	0.11				
9	35.60	253	0.25	0.18	0.18	0.25				
12	26.70	450	0.45	0.32	0.32	0.45				
24	13.30	1,800	1.80	1.30	1.30	1.80				
48	6.70	7,200	7.00	5.20	5.20	7.00				

Dual Coil Latching Low-sensitivity 4PDT (G6AK-474P-ST40-US - DISCONTINUED)

Rated voltage (VDC)	Rated current (mA)	Coil resistance (Ω)	Coil inductance (ref. value) (H)				Set pick-up voltage	Reset pick-up voltage	Maximum voltage	Power consumption (mW)
			Set coil		Reset coil					
			Armature OFF	Armature ON	Armature OFF	Armature ON				
3	120	25	0.02	0.02	0.02	0.02	70% max.	70% min.	150% at 23°C	Approx. 360
4.5	79.9	56.3	0.045	0.035	0.035	0.045				
5	72.50	69	0.065	0.05	0.05	0.065				
6	60	100	0.09	0.075	0.075	0.09				
9	40	225	0.18	0.14	0.14	0.18				
12	30	400	0.30	0.23	0.23	0.30				
24	15	1,600	1.20	0.82	0.82	1.20				
48	7.50	6,400	4.40	3.20	3.20	4.40				

- Note:**
1. The rated current and coil resistance are measured at a coil temperature of 23°C with a tolerance of ±10%.
 2. Operating characteristics are measured at a coil temperature of 23°C.
 3. The maximum voltage is the highest voltage that can be imposed on the relay coil.

■ Characteristics

Type		Non-latching	Latching
Contact resistance (See note 1)		50 mΩ max.	
Operate (set) time (See note 2)	DPDT	5 ms max. (mean value approx. 3 ms)	5 ms max. (mean value approx. 2.50 ms)
	4PDT - DISCONTINUED	7 ms max. (mean value approx. 3.80 ms)	7 ms max. (mean value approx. 3.30 ms)
Release (reset) time (See note 2)	DPDT	3 ms max. (mean value approx. 1.20 ms)	5 ms max. (mean value approx. 2.50 ms)
	4PDT - DISCONTINUED	5 ms max. (mean value approx. 1.30 ms)	7 ms max. (mean value approx. 2.70 ms)
Min. set/reset signal width	DPDT	7 ms min.	
	4PDT - DISCONTINUED	15 ms min.	
Operating frequency	Mechanical	36,000 operations/hour	
	Electrical	1,800 operations/hour (under rated load)	
Insulation resistance (See note 3)		1,000 MΩ min. (at 500 VDC); except for set-reset	
Dielectric strength		1,000 VAC, 50/60 Hz for 1 minute between coil and contacts 1,000 VAC, 50/60 Hz for 1 minute between contacts of different poles 1,000 VAC, 50/60 Hz for 1 minute between contacts of same pole 250 VAC, 50/60 Hz for 1 minute between set and reset coils	
Surge withstand voltage		1,500 V (10 x 160 μs) (conforms to FCC Part 68)	
Vibration	Mechanical durability	10 to 55 Hz; 5 mm double amplitude	
	Malfunction durability	10 to 55 Hz; 3.3 mm double amplitude	
Shock	Mechanical durability	1,000 m/s ² (Approx. 100G)	
	Malfunction durability	DPDT: 500 m/s ² (Approx. 50 G); 4PDT: 300 m/s ² (Approx. 30 G)	
Ambient temperature		-40° to 70°C with no icing	
Humidity		5% to 85% RH	
Service life	Mechanical	100 million operations min. (at 36,000 operations/hour)	
	Electrical	500,000 operations min. (at 1,800 operations/hr) See "Characteristic Data"	
Weight	DPDT	Approx. 3.5 g	
	4PDT - DISCONTINUED	Approx. 6.0 g	

- Note:**
1. The contact resistance was measured with 10 mA at 1 VDC with a fall-of-potential method.
 2. Values in parentheses are typical values unless otherwise stated.
 3. The insulation resistance was measured with a 500-VDC megohmmeter applied to the same parts as those for checking the dielectric strength (except between the set and reset coil).
 4. The above values are initial values.

■ Approvals

UL Recognized (File No. E41515) / CSA Certified (File No. LR31928) - - Ambient Temp. = 40°C

Type	Contact form	Coil rating	Contact ratings	Number of test operations
G6A()-274P-ST()-US	DPDT	1.5 to 48 VDC	1 A at 125 VAC (General Purpose) 2 A at 30 VDC (General Purpose) 0.6 A at 110 VDC (General Purpose)	6,000

- Note:**
1. The rated values approved by each of the safety standards (e.g., UL and CSA) may be different from the performance characteristics individually defined in this catalog.
 2. In the general interest of product improvement, specifications are subject to change.

Characteristic Data

Maximum Switching Capacity DPDT, 4PDT

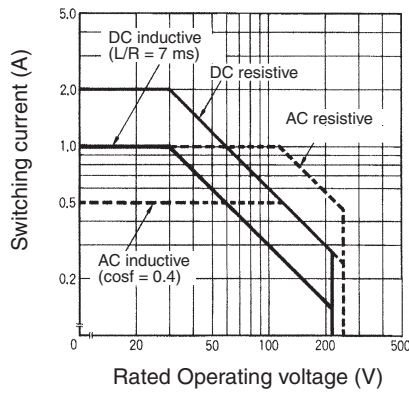

Ambient Temperature vs. Maximum Coil Voltage

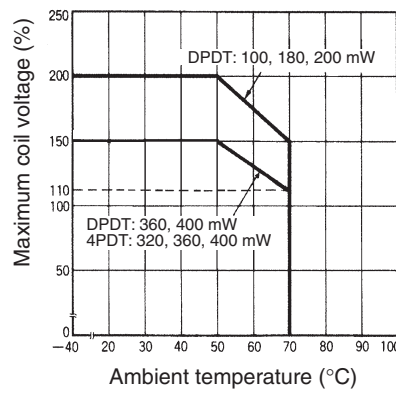

Note: The maximum coil voltage refers to the maximum value in a varying range of operating power voltage, not a continuous voltage.

Electrical Service Life DPDT

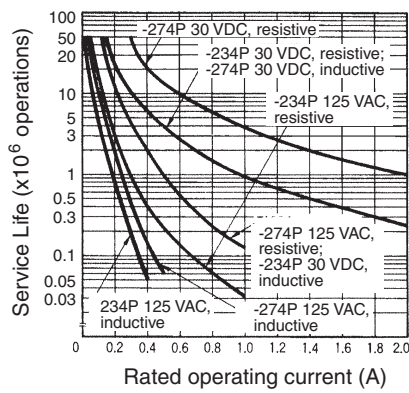

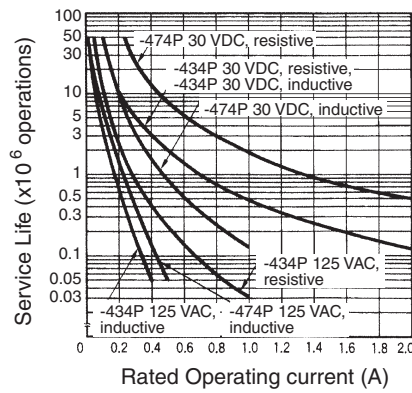

4PDT



Note: G6A-4 pole versions are discontinued.

Dimensions

- Note:** 1. All units are in millimeters unless otherwise indicated.
 2. Orientation marks are indicated as follows:  

■ Non-latching

G6A-274P-ST(40)-US

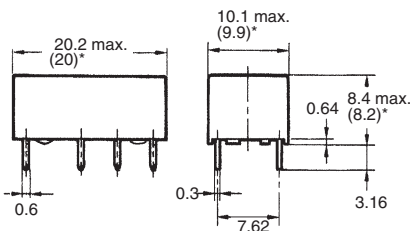
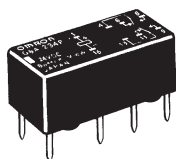

*Average value

**Terminal Arrangement/
Internal Connections
(Bottom View)**

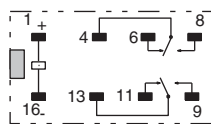

**Mounting Holes
(Bottom View)**

Tolerance: ± 0.1

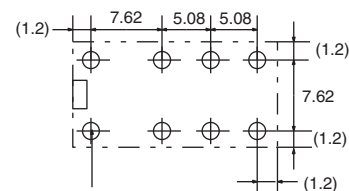

Eight, 1.0-dia. holes

G6A-474P-ST-US - DISCONTINUED

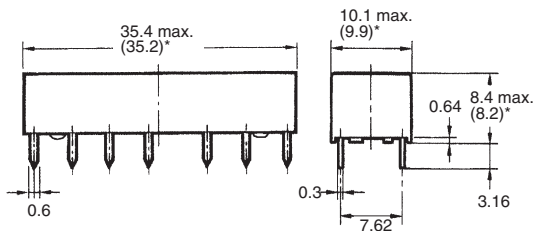
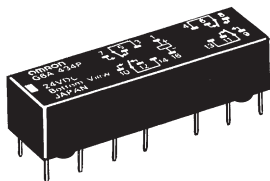

*Average value

**Terminal Arrangement/
Internal Connections
(Bottom View)**

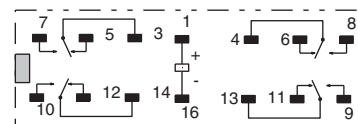

**Mounting Holes
(Bottom View)**

Tolerance: ± 0.1

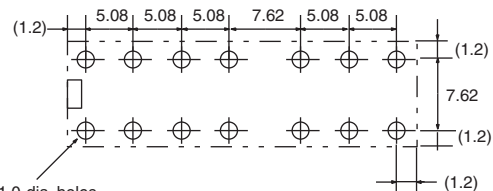

Fourteen, 1.0-dia. holes

■ Latching

G6AU-274P-ST-US

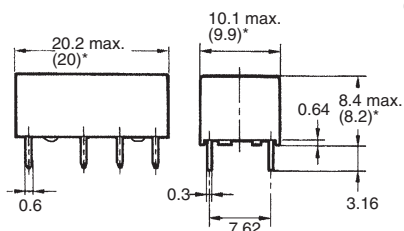
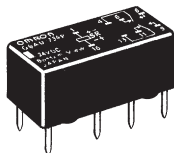

*Average value

**Terminal Arrangement/
Internal Connections
(Bottom View)**

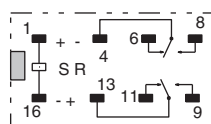

**Mounting Holes
(Bottom View)**

Tolerance: ± 0.1

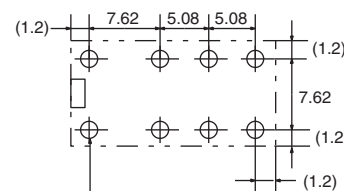

Eight, 1.0-dia. holes

G6AK-274P-ST(40)-US

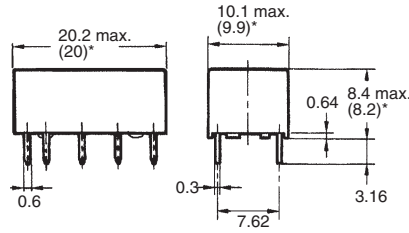
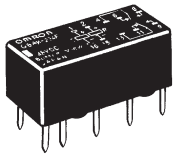

*Average value

**Terminal Arrangement/
Internal Connections
(Bottom View)**

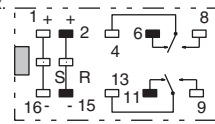

**Mounting Holes
(Bottom View)**

Tolerance: ± 0.1

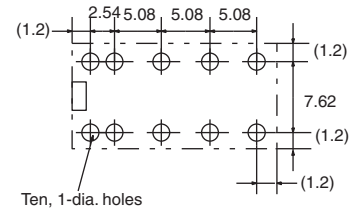

G6AU-474P-ST-US - DISCONTINUED

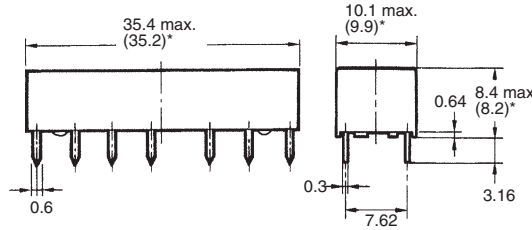
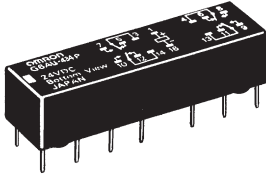

*Average value

**Terminal Arrangement/
Internal Connections
(Bottom View)**

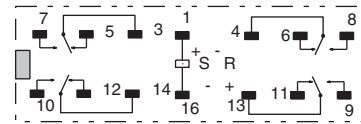

**Mounting Holes
(Bottom View)**

Tolerance: ± 0.1

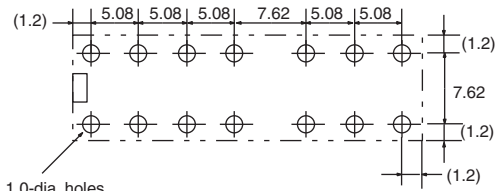

Fourteen, 1.0-dia. holes

G6AK-474P-ST(40)-US - DISCONTINUED

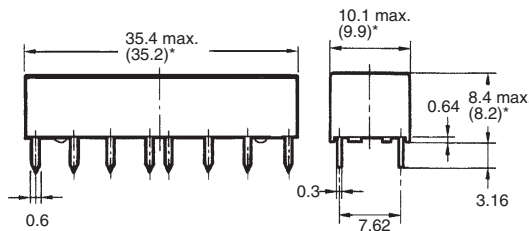
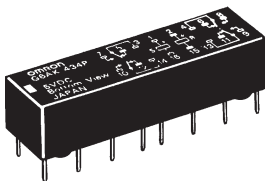

*Average value

**Terminal Arrangement/
Internal Connections
(Bottom View)**

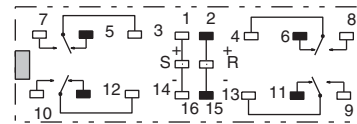

**Mounting Holes
(Bottom View)**

Tolerance: ± 0.1

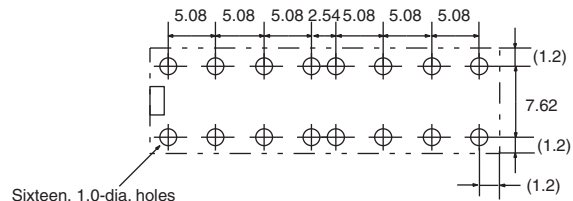

Sixteen, 1.0-dia. holes

Precautions

Long-term Continuously ON Contacts

Using the Relay in a circuit where the Relay will be ON continuously for long periods (without switching) can lead to unstable contacts because the heat generated by the coil itself will affect the insulation, causing a film to develop on the contact surfaces. Be sure to use a fail-safe circuit design that provides protection against contact failure or coil burnout. Otherwise, use a latching relay.

Relay Handling

When washing the product after soldering the Relay to a PCB, use a water-based solvent or alcohol-based solvent, and keep the solvent temperature to less than 40°C. Do not put the Relay in a cold cleaning bath immediately after soldering.

Omron Electronic Components, LLC

Terms and Conditions of Sales

I. GENERAL

- Definitions:** The words used herein are defined as follows.
 - Terms:** These terms and conditions
 - Seller:** Omron Electronic Components LLC and its subsidiaries
 - Buyer:** The buyer of Products, including any end user in section III through VI
 - Products:** Products and/or services of Seller
 - Including:** Including without limitation
- Offer; Acceptance:** These Terms are deemed part of all quotations, acknowledgments, invoices, purchase orders and other documents, whether electronic or in writing, relating to the sale of Products by Seller. Seller hereby objects to any Terms proposed in Buyer's purchase order or other documents which are inconsistent with, or in addition to, these Terms.
- Distributor:** Any distributor shall inform its customer of the contents after and including section III of these Terms.

II. SALES

- Prices; Payment:** All prices stated are current, subject to change without notice by Seller. Buyer agrees to pay the price in effect at the time the purchase order is accepted by Seller. Payments for Products received are due net 30 days unless otherwise stated in the invoice. Buyer shall have no right to set off any amounts against the amount owing in respect of this invoice.
- Discounts:** Cash discounts, if any, will apply only on the net amount of invoices sent to Buyer after deducting transportation charges, taxes and duties, and will be allowed only if (a) the invoice is paid according to Seller's payment terms and (b) Buyer has no past due amounts owing to Seller.
- Interest:** Seller, at its option, may charge Buyer 1.5% interest per month or the maximum legal rate, whichever is less, on any balance not paid within the stated terms.
- Orders:** Seller will accept no order less than 200 U.S. dollars net billing.
- Currencies:** If the prices quoted herein are in a currency other than U.S. dollars, Buyer shall make remittance to Seller at the then current exchange rate most favorable to Seller; provided that if remittance is not made when due, Buyer will convert the amount to U.S. dollars at the then current exchange rate most favorable to Seller available during the period between the due date and the date remittance is actually made.
- Governmental Approvals:** Buyer shall be responsible for all costs involved in obtaining any government approvals regarding the importation or sale of the Products.
- Taxes:** All taxes, duties and other governmental charges (other than general real property and income taxes), including any interest or penalties thereon, imposed directly or indirectly on Seller or required to be collected directly or indirectly by Seller for the manufacture, production, sale, delivery, importation, consumption or use of the Products sold hereunder (including customs duties and sales, excise, use, turnover and license taxes) shall be charged to and remitted by Buyer to Seller.
- Financial:** If the financial position of Buyer at any time becomes unsatisfactory to Seller, Seller reserves the right to stop shipments or require satisfactory security or payment in advance. If Buyer fails to make payment or otherwise comply with these Terms or any related agreement, Seller may (without liability and in addition to other remedies) cancel any unshipped portion of Products sold hereunder and stop any Products in transit until Buyer pays all amounts, including amounts payable hereunder, whether or not then due, which are owing to it by Buyer. Buyer shall in any event remain liable for all unpaid accounts.
- Cancellation; Etc:** Orders are not subject to rescheduling or cancellation unless Buyer indemnifies Seller fully against all costs or expenses arising in connection therewith.
- Force Majeure:** Seller shall not be liable for any delay or failure in delivery resulting from causes beyond its control, including earthquakes, fires, floods, strikes or other labor disputes, shortage of labor or materials, accidents to machinery, acts of sabotage, riots, delay in or lack of transportation or the requirements of any government authority.
- Shipping; Delivery:** Unless otherwise expressly agreed in writing by Seller:
 - All sales and shipments of Products shall be FOB shipping point (unless otherwise stated in writing by Seller), at which point title to and all risk of loss of the Products shall pass from Seller to Buyer, provided that Seller shall retain a security interest in the Products until the full purchase price is paid by Buyer;
 - Delivery and shipping dates are estimates only; and
 - Seller will package Products as it deems proper for protection against normal handling and extra charges apply to special conditions.
- Claims:** Any claim by Buyer against Seller for shortage or damage to the Products occurring before delivery to the carrier or any claim related to pricing or other charges must be presented in detail in writing to Seller within 30 days of receipt of shipment.

III. PRECAUTIONS

- Suitability:** IT IS THE BUYER'S SOLE RESPONSIBILITY TO ENSURE THAT ANY OMRON PRODUCT IS FIT AND SUFFICIENT FOR USE IN A MOTORIZED VEHICLE APPLICATION. BUYER SHALL BE SOLELY RESPONSIBLE FOR DETERMINING APPROPRIATENESS OF THE PARTICULAR PRODUCT WITH RESPECT TO THE BUYER'S APPLICATION INCLUDING (A) ELECTRICAL OR ELECTRONIC COMPONENTS, (B) CIRCUITS, (C) SYSTEM ASSEMBLIES, (D) END PRODUCT, (E) SYSTEM, (F) MATERIALS OR SUBSTANCES OR (G) OPERATING ENVIRONMENT. Buyer acknowledges that it alone has determined that the Products will meet their requirements of the intended use in all cases. Buyer must know and observe all prohibitions of use applicable to the Product/s.
- Use with Attention:** The followings are some examples of applications for which particular attention must be given. This is not intended to be an exhaustive list of all possible use of any Product, nor to imply that any use listed may be suitable for any Product:
 - Outdoor use, use involving potential chemical contamination or electrical interference.

- Use in consumer Products or any use in significant quantities.
 - Energy control systems, combustion systems, railroad systems, aviation systems, medical equipment, amusement machines, vehicles, safety equipment, and installations subject to separate industry or government regulations.
 - Systems, machines, and equipment that could present a risk to life or property.
- Prohibited Use:** NEVER USE THE PRODUCT FOR AN APPLICATION INVOLVING SERIOUS RISK TO LIFE OR PROPERTY WITHOUT ENSURING THAT THE SYSTEM AS A WHOLE HAS BEEN DESIGNED TO ADDRESS THE RISKS, AND THAT THE PRODUCT IS PROPERLY RATED AND INSTALLED FOR THE INTENDED USE WITHIN THE OVERALL EQUIPMENT OR SYSTEM.
 - Motorized Vehicle Application:** USE OF ANY PRODUCT/S FOR A MOTORIZED VEHICLE APPLICATION MUST BE EXPRESSLY STATED IN THE SPECIFICATION BY SELLER.
 - Programmable Products:** Seller shall not be responsible for the Buyer's programming of a programmable Product.

IV. WARRANTY AND LIMITATION

- Warranty:** Seller's exclusive warranty is that the Products will be free from defects in materials and workmanship for a period of twelve months from the date of sale by Seller (or such other period expressed in writing by Seller). SELLER MAKES NO WARRANTY OR REPRESENTATION, EXPRESS OR IMPLIED, ABOUT ALL OTHER WARRANTIES, NON-INFRINGEMENT, MERCHANTABILITY OR FITNESS FOR A PARTICULAR PURPOSE OF THE PRODUCTS.
- Buyer Remedy:** Seller's sole obligation hereunder shall be to replace (in the form originally shipped with Buyer responsible for labor charges for removal or replacement thereof) the non-complying Product or, at Seller's election, to repay or credit Buyer an amount equal to the purchase price of the Product; provided that there shall be no liability for Seller or its affiliates unless Seller's analysis confirms that the Products were correctly handled, stored, installed and maintained and not subject to contamination, abuse, misuse or inappropriate modification. Return of any Products by Buyer must be approved in writing by Seller before shipment.
- Limitation on Liability:** SELLER AND ITS AFFILIATES SHALL NOT BE LIABLE FOR SPECIAL, INDIRECT, INCIDENTAL OR CONSEQUENTIAL DAMAGES, LOSS OF PROFITS OR PRODUCTION OR COMMERCIAL LOSS IN ANY WAY CONNECTED WITH THE PRODUCTS, WHETHER SUCH CLAIM IS BASED IN CONTRACT, WARRANTY, NEGLIGENCE OR STRICT LIABILITY. FURTHER, IN NO EVENT SHALL LIABILITY OF SELLER OR ITS AFFILIATES EXCEED THE INDIVIDUAL PRICE OF THE PRODUCT ON WHICH LIABILITY IS ASSERTED.
- Indemnities:** Buyer shall indemnify and hold harmless Seller, its affiliates and its employees from and against all liabilities, losses, claims, costs and expenses (including attorney's fees and expenses) related to any claim, investigation, litigation or proceeding (whether or not Seller is a party) which arises or is alleged to arise from Buyer's acts or omissions under these Terms or in any way with respect to the Products.

V. INFORMATION; ETC.

- Intellectual Property:** The intellectual property embodied in the Products is the exclusive property of Seller and its affiliates and Buyer shall not attempt to duplicate it in any way without the written permission of Seller. Buyer (at its own expense) shall indemnify and hold harmless Seller and defend or settle any action brought against Seller to the extent that it is based on a claim that any Product made to Buyer specifications infringed intellectual property rights of another party.
- Property; Confidentiality:** Notwithstanding any charges to Buyer for engineering or tooling, all engineering and tooling shall remain the exclusive property of Seller. All information and materials supplied by Seller to Buyer relating to the Products are confidential and proprietary, and Buyer shall limit distribution thereof to its trusted employees and strictly prevent disclosure to any third party.
- Performance Data:** Performance data is provided as a guide in determining suitability and does not constitute a warranty. It may represent the result of Seller's test conditions, and the users must correlate it to actual application requirements.
- Change In Specifications:** Product specifications and descriptions may be changed at any time based on improvements or other reasons. It is Seller's practice to change part numbers when published ratings or features are changed, or when significant engineering changes are made. However, some specifications of the Product may be changed without any notice.
- Errors And Omissions:** The information on Seller's website or in other documentation has been carefully checked and is believed to be accurate; however, no responsibility is assumed for clerical, typographical or proofreading errors or omissions.
- Export Controls:** Buyer shall comply with all applicable laws, regulations and licenses regarding (a) export of the Products or information provided by Seller; (b) sale of Products to forbidden or other proscribed persons or organizations; (c) disclosure to non-citizens of regulated technology or information.

VI. MISCELLANEOUS

- Waiver:** No failure or delay by Seller in exercising any right and no course of dealing between Buyer and Seller shall operate as a waiver of rights by Seller.
- Assignment:** Buyer may not assign its rights hereunder without Seller's written consent.
- Law:** These Terms are governed by Illinois law (without regard to conflict of laws). Federal and state courts in Cook County, Illinois have exclusive jurisdiction for any dispute hereunder.
- Amendment:** These Terms constitute the entire agreement between Buyer and Seller relating to the Products, and no provision may be changed or waived unless in writing signed by the parties.
- Severability:** If any provision hereof is rendered ineffective or invalid, such provision shall not invalidate any other provision.

Certain Precautions on Specifications and Use

1. **Suitability for Use.** Seller shall not be responsible for conformity with any standards, codes or regulations which apply to the combination of the Product in Buyer's application or use of the Product. At Buyer's request, Seller will provide applicable third party certification documents identifying ratings and limitations of use which apply to the Product. This information by itself is not sufficient for a complete determination of the suitability of the Product in combination with the end product, machine, system, or other application or use. Buyer shall be solely responsible for determining appropriateness of the particular Product with respect to Buyer's application, product or system. Buyer shall take application responsibility in all cases but the following is a non-exhaustive list of applications for which particular attention must be given:
 - (i) Outdoor use, uses involving potential chemical contamination or electrical interference, or conditions or uses not described in this document.
 - (ii) Energy control systems, combustion systems, railroad systems, aviation systems, medical equipment, amusement machines, vehicles, safety equipment, and installations subject to separate industry or government regulations.
 - (iii) Use in consumer products or any use in significant quantities.
 - (iv) Systems, machines and equipment that could present a risk to life or property. Please know and observe all prohibitions of use applicable to this product.

NEVER USE THE PRODUCT FOR AN APPLICATION INVOLVING SERIOUS RISK TO LIFE OR PROPERTY WITHOUT ENSURING THAT THE SYSTEM AS A WHOLE HAS BEEN DESIGNED TO ADDRESS THE RISKS, AND THAT THE OMRON PRODUCT IS PROPERLY RATED AND INSTALLED FOR THE INTENDED USE WITHIN THE OVERALL EQUIPMENT OR SYSTEM.
2. **Programmable Products.** Seller shall not be responsible for the user's programming of a programmable product, or any consequence thereof.
3. **Performance Data.** Performance data given in this publication is provided as a guide for the user in determining suitability and does not constitute a warranty. It may represent the result of Seller's test conditions, and the users must correlate it to actual application requirements. Actual performance is subject to Seller's Warranty and Limitations of Liability.
4. **Change in Specifications.** Product specifications and accessories may be changed at any time based on improvements and other reasons. It is our practice to change part numbers when published ratings or features are changed, or when significant construction changes are made. However, some specifications of the Product may be changed without any notice. When in doubt, special part numbers may be assigned to fix or establish key specifications for your application. Please consult with your Seller representative at any time to confirm actual specifications of purchased Product.
5. **Errors and Omissions.** The information in this publication has been carefully checked and is believed to be accurate; however, no responsibility is assumed for clerical, typographical or proofreading errors, or omissions.
6. **RoHS Compliance.** Where indicated, our products currently comply, to the best of our knowledge as of the date of this publication, with the requirements of the European Union's Directive on the Restriction of certain Hazardous Substances ("RoHS"), although the requirements of RoHS do not take effect until July 2006. These requirements may be subject to change. Please consult our website for current information.

Complete "Terms and Conditions of Sale" for product purchase and use are on Omron's website at <http://www.components.omron.com> – under the "About Us" tab, in the Legal Matters section.

ALL DIMENSIONS SHOWN ARE IN MILLIMETERS.

To convert millimeters into inches, multiply by 0.03937. To convert grams into ounces, multiply by 0.03527.

OMRON®

**OMRON ELECTRONIC
COMPONENTS LLC**

55 E. Commerce Drive, Suite B
Schaumburg, IL 60173

847-882-2288

OMRON ON-LINE

Global - <http://www.omron.com>

USA - <http://www.components.omron.com>