



# Stereo Headphone Power Amplifier

## Features

- High performance Class AB amplifier
- High signal-to-noise ratio
- Low distortion
- Low power consumption
- Large output voltage swing
- Excellent power supply ripple rejection
- 3.0V to 6.5V supply voltage range
- Surface-Mount package-SOP 8

## Applications

- CD-ROM
- DVD-ROM
- CD-R/W
- MP3
- Portable Stereo

## General Description

The G1402 is an output rail-to-rail stereo audio power amplifier housed in a 8-pin SOP package capable of delivering 125mW of continuous power into 16Ω loads & 75mW into 32Ω loads with the THD <0.1% per channel.

The gain setting of the amplifiers can simply achieve by setting two external resistors  $R_i$  (input resistor) &  $R_f$  (feedback resistor) promptly.

The G1402 is a dual channel, low voltage, low power, and high performance amplifiers. The quiescent current is 3mA @ 5V typically. With excellent AC performance (small THD), it can be designed into a wide range of headphone driving applications.

## Ordering Information

ORDER NUMBER	MARKING	TEMP. RANGE	PACKAGE
G1402P1X	G1402	-40°C to +85°C	SOP-8L
G1402P1Xf	G1402	-40°C to +85°C	SOP-8L (Pb free)

Note: X Specify the packing type  
U: Tape & Reel                      T: Tube

## Pin Configuration

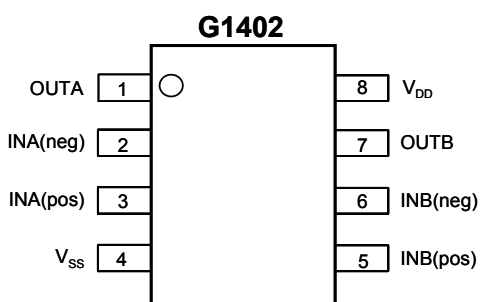

SYMBOL	PIN	DESCRIPTION
OUTA	1	output A
INA(neg)	2	inverting input A
INA(pos)	3	non-inverting input A
V <sub>ss</sub>	4	negative supply
INB(pos)	5	non-inverting input B
INB(neg)	6	inverting input B
OUTB	7	output B
V <sub>DD</sub>	8	positive supply

## Block Diagram

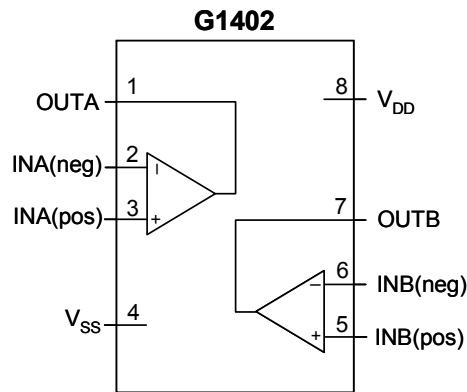

## Absolute Maximum Ratings (Note1)

SYMBOL	PARAMETER	CONDITION	MIN	MAX	UNIT
$V_{DD}$	Supply voltage		0	7.0	V
$T_{stg}$	Storage temperature		-65	+150	°C
$T_{amb}$	Operating ambient temperature		-40	+85	°C
ESD	ESD voltage	HBM	-	2	KV

### Notes:

1. Absolute Maximum Ratings are limits beyond which damage to the device may occur.

## Thermal Characteristics

SYMBOL	PARAMETER	VALUE	UNIT
$R_{th(j-a)}$	Thermal resistance from junction to ambient in free air SO8	240	°C/W

## Test and Application Information

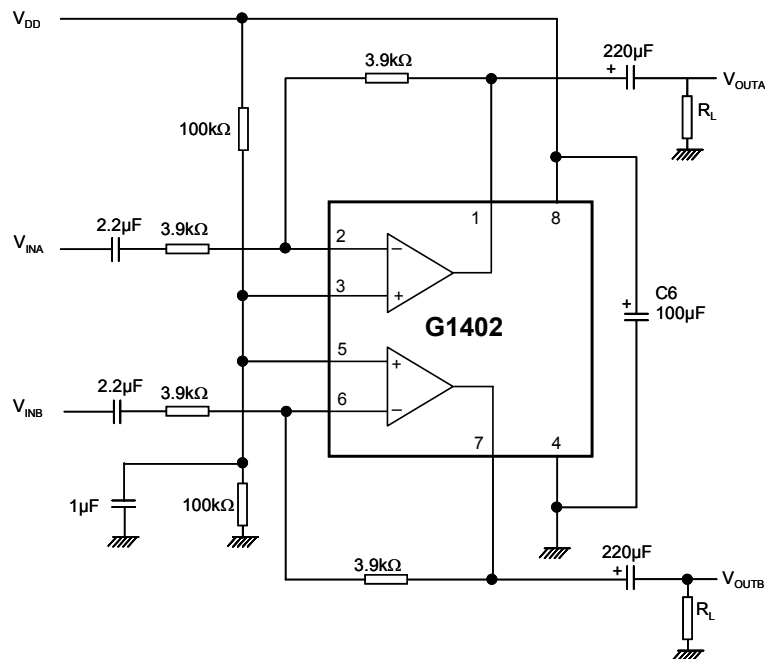

Fig.1 Measurement circuit for inverting application

**Electrical Characteristics** $V_{DD} = 5V$ ;  $V_{SS} = 0V$ ;  $T_A = 25^\circ C$ ;  $f_i = 1kHz$ ;  $R_L = 32\Omega$  connected to  $V_{DD}/2$ ; unless otherwise specified.

SYMBOL	PARAMETER	CONDITION	MIN	TYP	MAX	UNIT
<b>Supplies</b>						
$V_{DD}$	Supply voltage		3.0	5.0	6.5	V
	Single		3.0	5.0	6.5	V
	Dual		1.5	2.5	3.25	V
$V_{SS}$	Negative supply voltage		-1.5	-2.5	-3.25	V
$I_{DD}$	Supply current	no load	-	3.0	5.0	mA
$P_{tot}$	Total power dissipation	no load	-	15	25	mW
<b>DC Characteristics</b>						
$V_{I(OS)}$	Input offset voltage		-50	-	50	mV
$V_{CM}$	Common mode voltage		0	-	3.5	V
$G_V$	Open-loop voltage gain	$R_L = 5k\Omega$	60	90	-	dB
$I_O$	Maximum output current	THD+N <0.1%	-	70	-	mA
$R_O$	Output resistance	closed-loop	-	0.1	-	$\Omega$
$V_{DD}-V_{OH}$	Output Voltage Swing High	Sourcing current = 100mA	-	0.4	1	V
$V_{OL}-V_{SS}$	Output Voltage Swing Low	Sinking current = 100mA	-	0.5	1	V
PSRR	Power supply rejection ratio	$f_i = 1kHz$ ; $V_{ripple(rms)} = 100mV_{rms}$	-	70	-	dB
$\alpha_{CS}$	Channel separation	$R_L=32\Omega, C_b=1\mu F, P_O=70mW$	-	65	-	dB
<b>AC Characteristics</b>						
THD	Total harmonic distortion	note 2	-	< 0.1	-	%
$f_G$	Unity gain frequency	open-loop; $R_L = 5k\Omega$	-	5	-	MHz
$P_O$	Maximum output power	note 1; $R_L = 16\Omega$ ; $f=1kHz$	-	125	-	mW
		note 1; $R_L = 32\Omega$ ; $f=1kHz$	-	75	-	mW

**Notes:**

- Values are proportional to  $V_{DD}$ ; THD+N < 0.1%
- $V_{DD} = 5.0V$ ;  $V_{O(P-P)} = 4.0V$  (at 0 dB)



Electrical Characteristics

C<sub>IN</sub>=2.2μF, C<sub>OUT</sub>=330μF, C<sub>b</sub>=1μF, A<sub>v</sub>=1, R<sub>i</sub>=18k, R<sub>f</sub>=18k ; A<sub>v</sub>=-2, R<sub>i</sub>=18k, R<sub>f</sub>=36k ; A<sub>v</sub>=-4, R<sub>i</sub>=9k, R<sub>f</sub>=36k, T<sub>A</sub>=25°C

THD+N vs Output Power

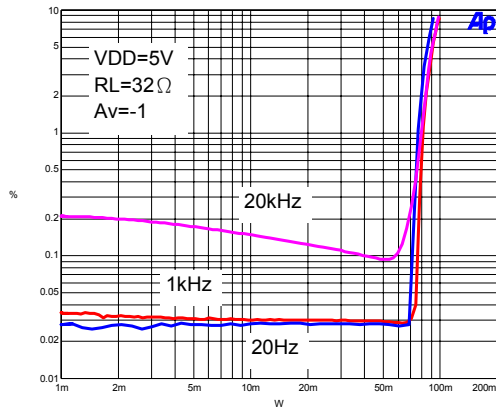

THD+N vs Frequency

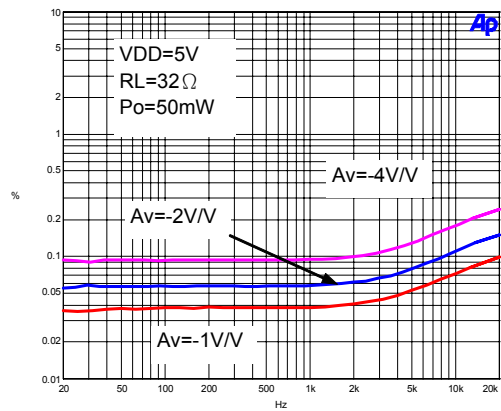

THD+N vs Frequency

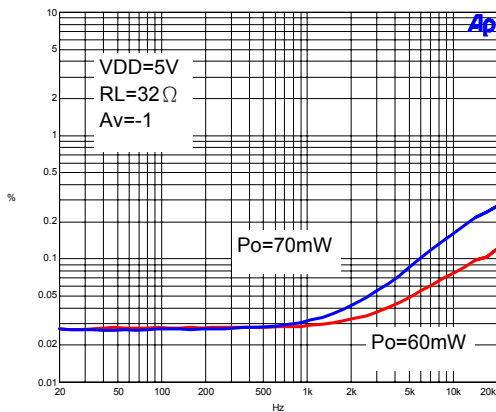

THD+N vs Output Power

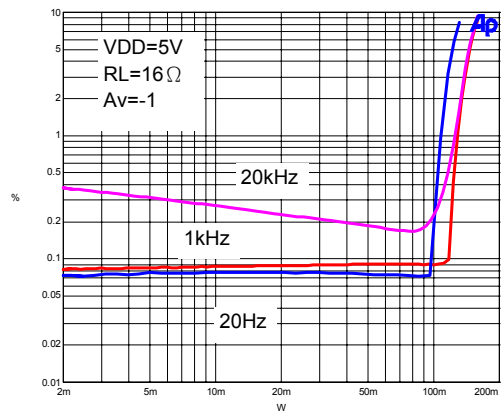

THD+N vs Frequency

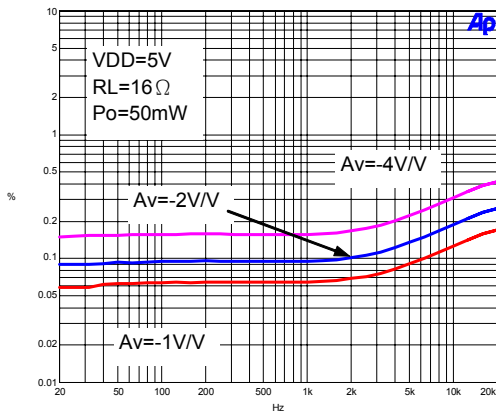

THD+N vs Output Power

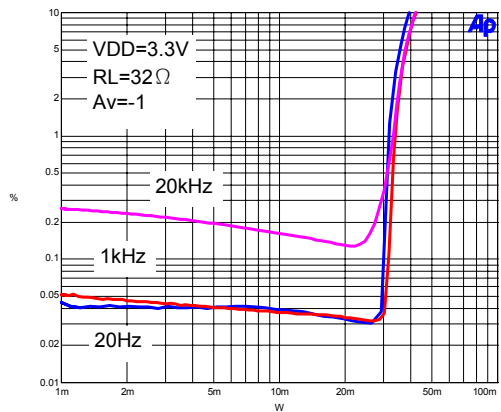



Electrical Characteristics (continued)

THD+N vs Frequency

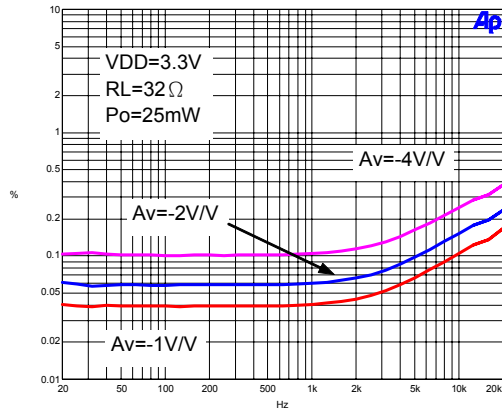

THD+N vs Output Power

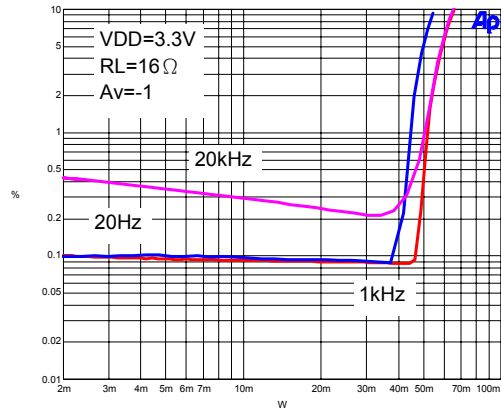

THD+N vs Frequency

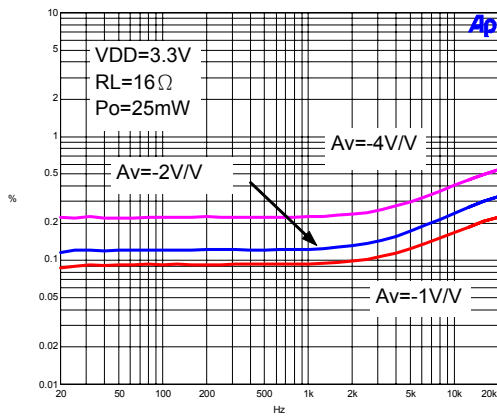

Output Noise

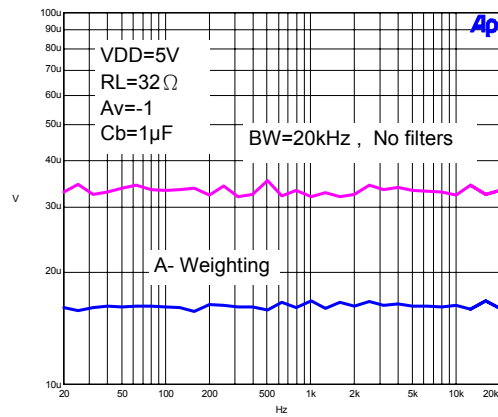

Channel Separation

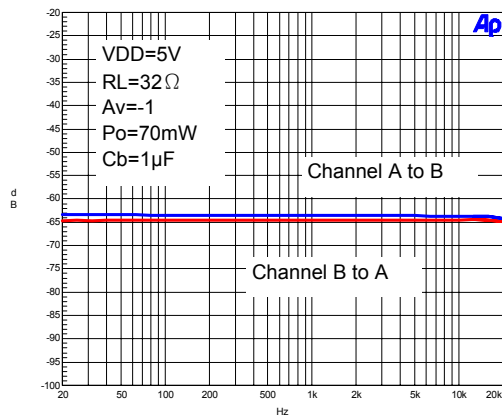

Power Supply Rejection Ratio

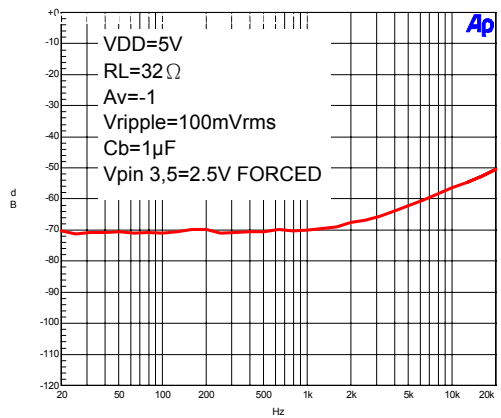



Electrical Characteristics (continued)

Open Loop Frequency Response

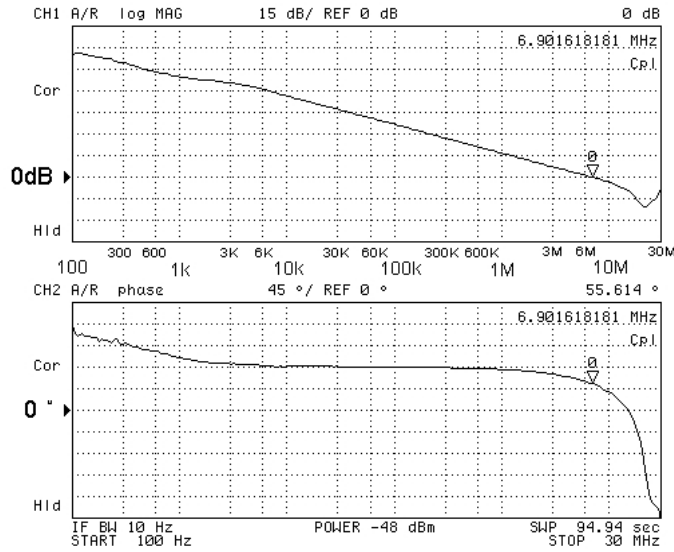

VDD=5V  
RL=5K

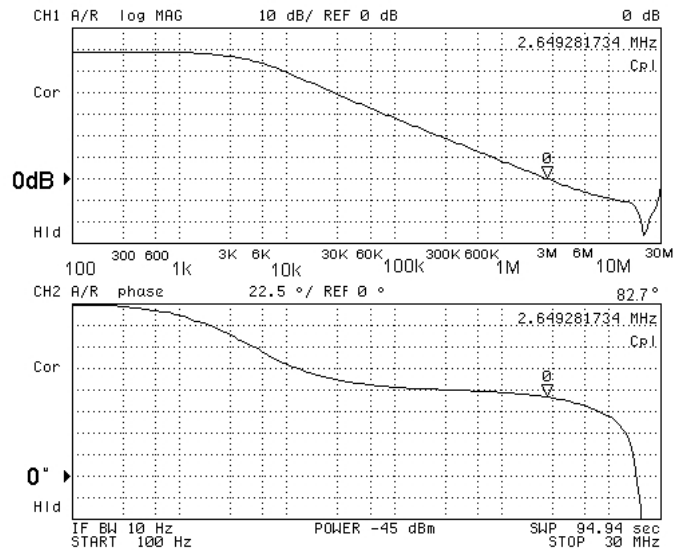

VDD=5V  
RL=32 ohm



## Electrical Characteristics (continued)

### Supply Current vs. Supply Voltage

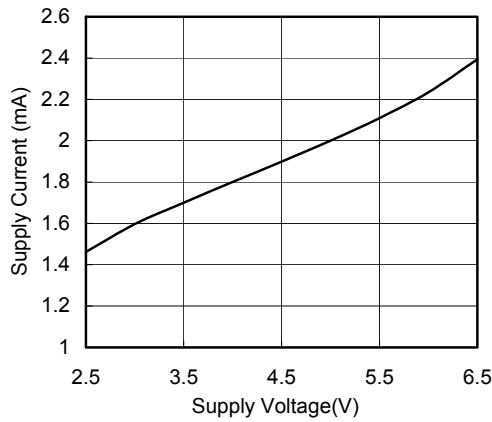

### Supply Current vs. Temperature

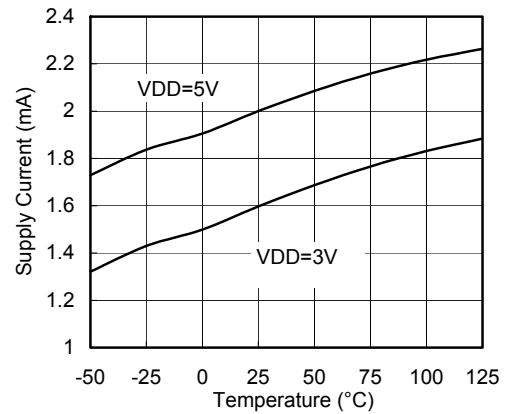

### Offset Voltage vs. Supply Voltage

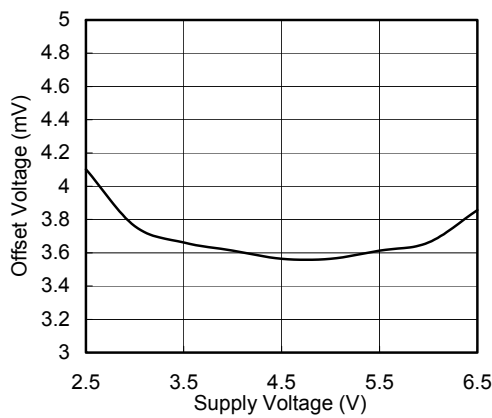

### Offset Voltage vs. Temperature

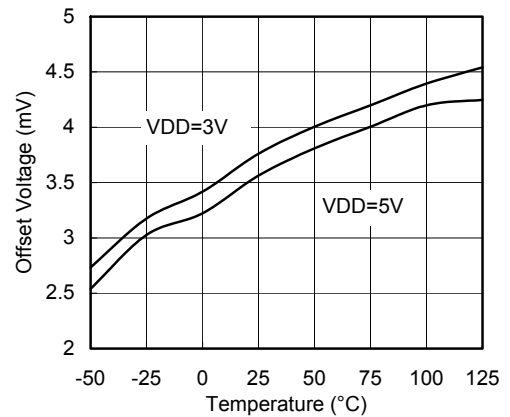

### Sinking Current vs. Vo-Vss

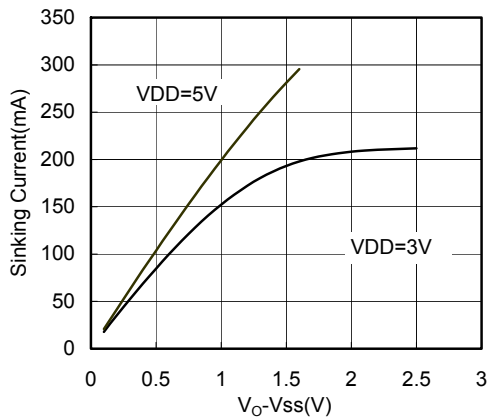

### Sourcing Current vs. VDD-Vo

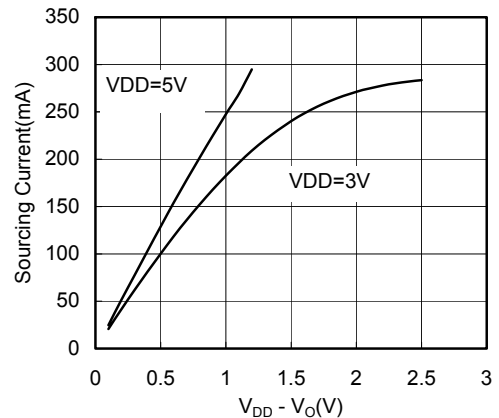

**Package Information**

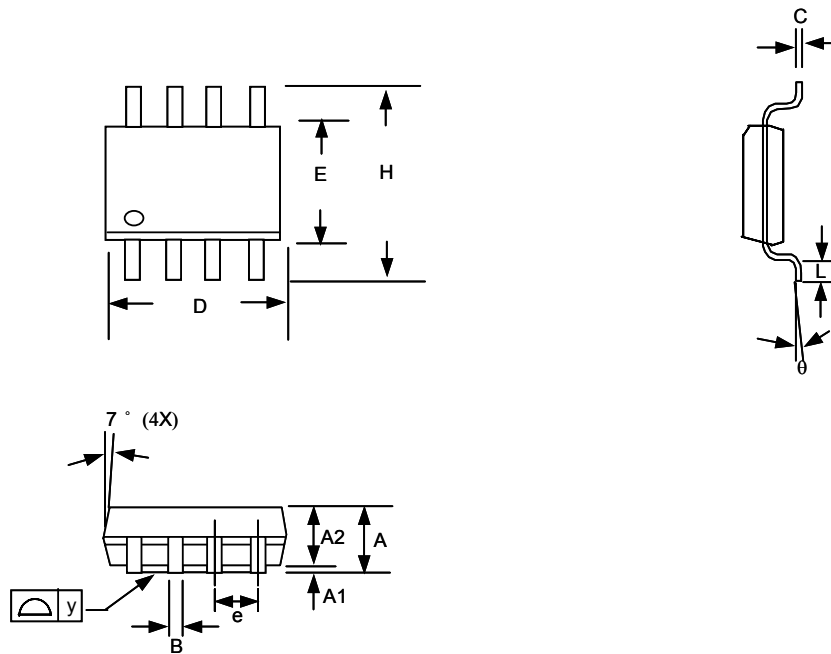

1. Package body sizes exclude mold flash and gate burrs
2. Dimension L is measured in gage plane
3. Tolerance 0.10mm unless otherwise specified
4. Controlling dimension is millimeter converted inch dimensions are not necessarily exact.

SYMBOL	DIMENSION IN MM			DIMENSION IN INCH		
	MIN.	NOM.	MAX.	MIN.	NOM.	MAX.
A	1.35	1.60	1.75	0.053	0.063	0.069
A1	0.10	----	0.25	0.004	----	0.010
A2	----	1.45	----	----	0.057	----
B	0.33	----	0.51	0.013	----	0.020
C	0.19	----	0.25	0.007	----	0.010
D	4.80	----	5.00	0.189	----	0.197
E	3.80	----	4.00	0.150	----	0.157
e	----	1.27	----	----	0.050	----
H	5.80	----	6.20	0.228	----	0.244
L	0.40	----	1.27	0.016	----	0.050
y	----	----	0.10	----	----	0.004
$\theta$	0°	----	8°	0°	----	8°

**Taping Specification**

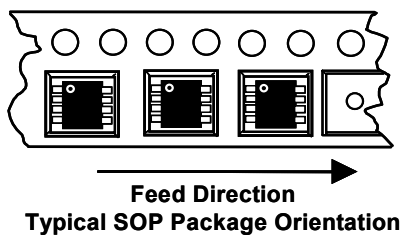

GMT Inc. does not assume any responsibility for use of any circuitry described, no circuit patent licenses are implied and GMT Inc. reserves the right at any time without notice to change said circuitry and specifications.