

# 2MBI600NT-060

IGBT Module

## 600V / 600A 2 in one-package

### ■ Features

- VCE(sat) classified for easy parallel connection
- High speed switching
- Voltage drive
- Low inductance module structure

### ■ Applications

- Inverter for Motor drive
- AC and DC Servo drive amplifier
- Uninterruptible power supply
- Industrial machines, such as Welding machines

### ■ Maximum ratings and characteristics

#### ● Absolute maximum ratings (at Tc=25°C unless otherwise specified)

Item	Symbol	Rating	Unit
Collector-Emitter voltage	V <sub>CEs</sub>	600	V
Gate-Emitter voltage	V <sub>GES</sub>	±20	V
Collector current	Continuous	I <sub>c</sub>	600
	1ms	I <sub>c</sub> pulse	1200
		-I <sub>c</sub>	600
	1ms	-I <sub>c</sub> pulse	1200
Max. power dissipation	P <sub>c</sub>	2500	W
Operating temperature	T <sub>j</sub>	+150	°C
Storage temperature	T <sub>stg</sub>	-40 to +125	°C
Isolation voltage	V <sub>is</sub>	AC 2500 (1min.)	V
Screw torque	Mounting *1	3.5	N·m
	Terminals *2	4.5	N·m

\*1 : Recommendable value : 2.5 to 3.5N·m (M5) or (M6)

\*2 : Recommendable value : 3.5 to 4.5N·m (M6)

#### ● Electrical characteristics (at Tj=25°C unless otherwise specified)

Item	Symbol	Characteristics			Conditions	Unit
		Min.	Typ.	Max.		
Zero gate voltage collector current	I <sub>CEs</sub>	–	–	4.0	V <sub>GE</sub> =0V, V <sub>CE</sub> =600V	mA
Gate-Emitter leakage current	I <sub>GES</sub>	–	–	60	V <sub>CE</sub> =0V, V <sub>GE</sub> =±20V	µA
Gate-Emitter threshold voltage	V <sub>GE(th)</sub>	4.5	–	7.5	V <sub>CE</sub> =20V, I <sub>c</sub> =600mA	V
Collector-Emitter saturation voltage	V <sub>CE(sat)</sub>	–	–	2.9	V <sub>GE</sub> =15V, I <sub>c</sub> =600A	V
Input capacitance	C <sub>ies</sub>	–	39600	–	V <sub>GE</sub> =0V	pF
Output capacitance	C <sub>oes</sub>	–	8800	–	V <sub>CE</sub> =10V	
Reverse transfer capacitance	C <sub>res</sub>	–	2670	–	f=1MHz	
Turn-on time	t <sub>on</sub>	–	0.6	1.2	V <sub>CC</sub> =300V	µs
	t <sub>r</sub>	–	0.2	0.6	I <sub>c</sub> =600A	
Turn-off time	t <sub>off</sub>	–	0.6	1.0	V <sub>GE</sub> =±15V	
	t <sub>f</sub>	–	0.2	0.35	R <sub>G</sub> =2.7ohm	
Diode forward on voltage	V <sub>F</sub>	–	–	3.1	I <sub>F</sub> =600A, V <sub>GE</sub> =0V	V
Reverse recovery time	t <sub>rr</sub>	–	–	0.3	I <sub>F</sub> =600A	µs

#### ● Thermal resistance characteristics

Item	Symbol	Characteristics			Conditions	Unit
		Min.	Typ.	Max.		
Thermal resistance	R <sub>th(j-c)</sub>	–	–	0.05	IGBT	°C/W
	R <sub>th(j-c)</sub>	–	–	0.1	Diode	°C/W
	R <sub>th(c-f)*</sub>	–	0.0167	–	the base to cooling fin	°C/W

\* : This is the value which is defined mounting on the additional cooling fin with thermal compound



### ■ Equivalent Circuit Schematic

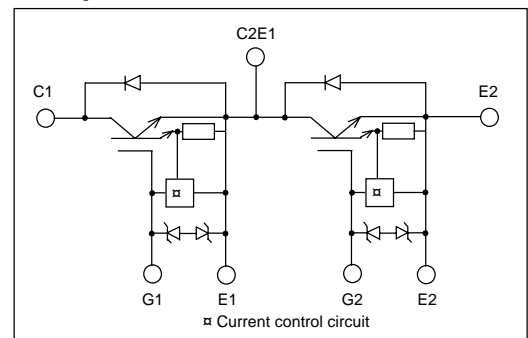

■ Characteristics (Representative)

Collector current vs. Collector-Emitter voltage  
T<sub>J</sub>=25°C

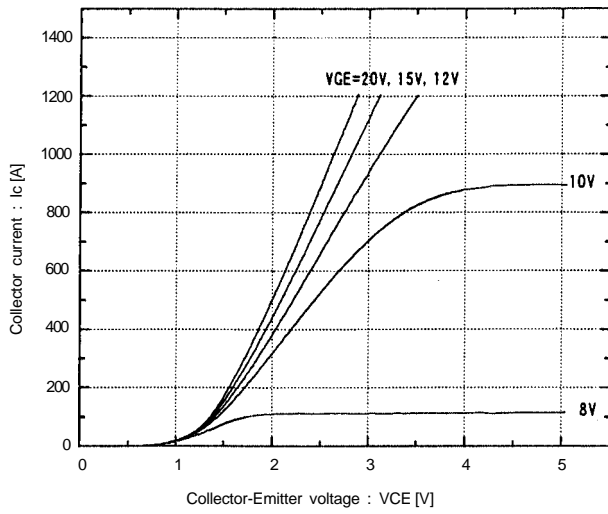

Collector current vs. Collector-Emitter voltage  
T<sub>J</sub>=125°C

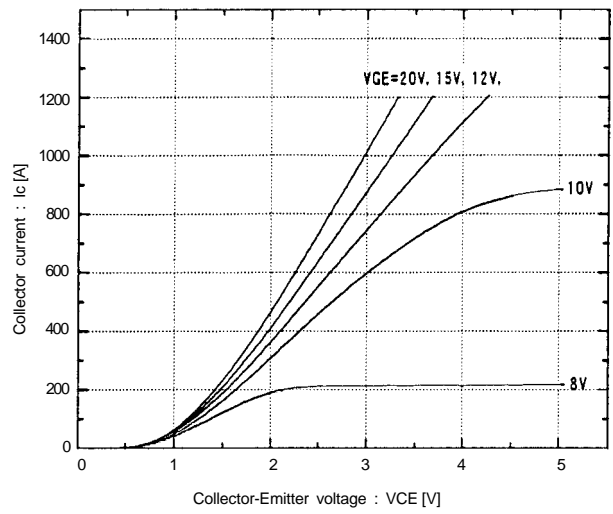

Collector-Emitter vs. Gate-Emitter voltage  
T<sub>J</sub>=25°C

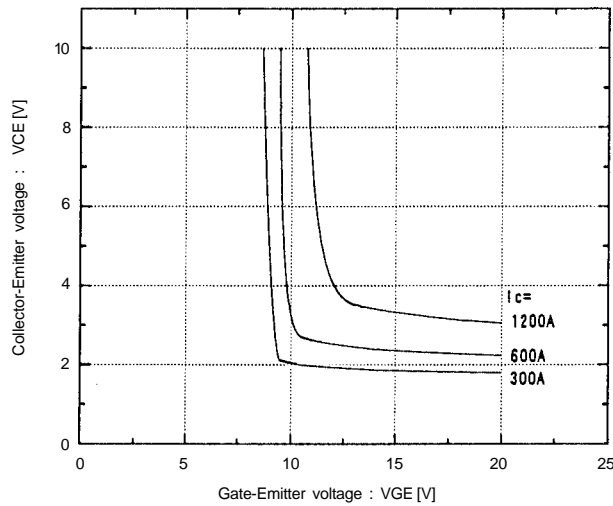

Collector-Emitter vs. Gate-Emitter voltage  
T<sub>J</sub>=125°C

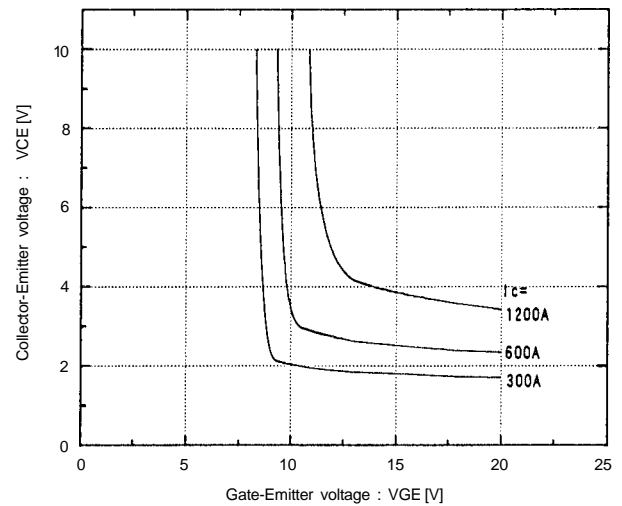

Switching time vs. Collector current  
V<sub>CC</sub>=300V, R<sub>G</sub>=2.7 ohm, V<sub>GE</sub>=±15V, T<sub>J</sub>=25°C

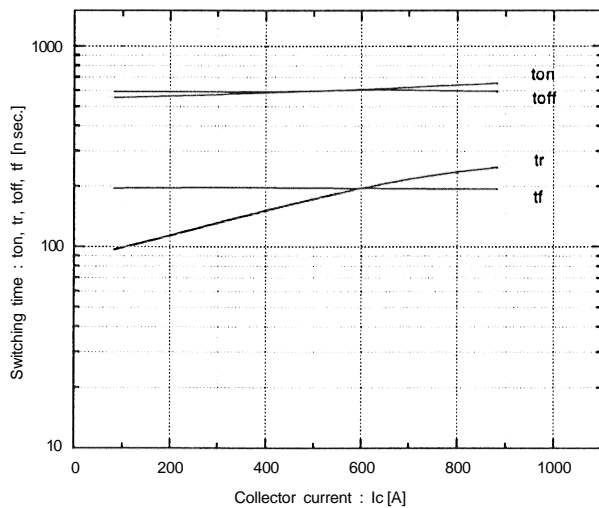

Switching time vs. Collector current  
V<sub>CC</sub>=300V, R<sub>G</sub>=2.7 ohm, V<sub>GE</sub>=±15V, T<sub>J</sub>=125°C

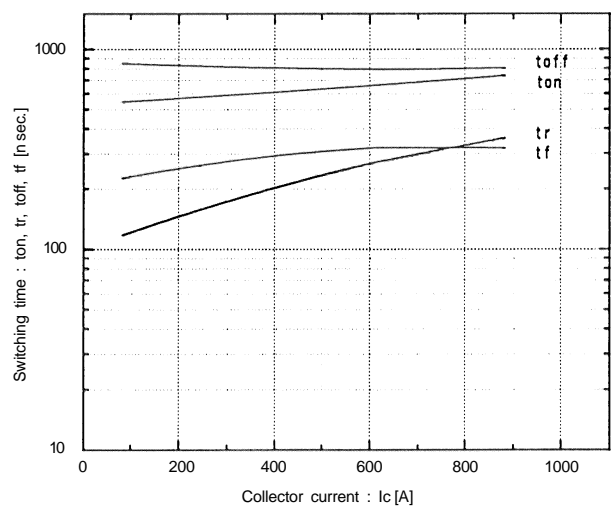

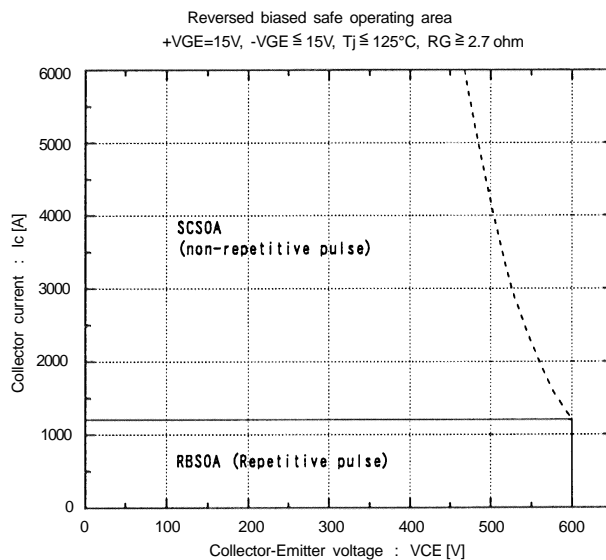
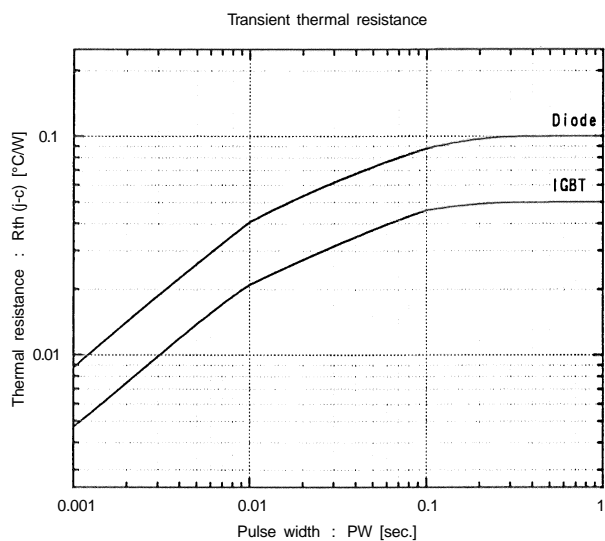
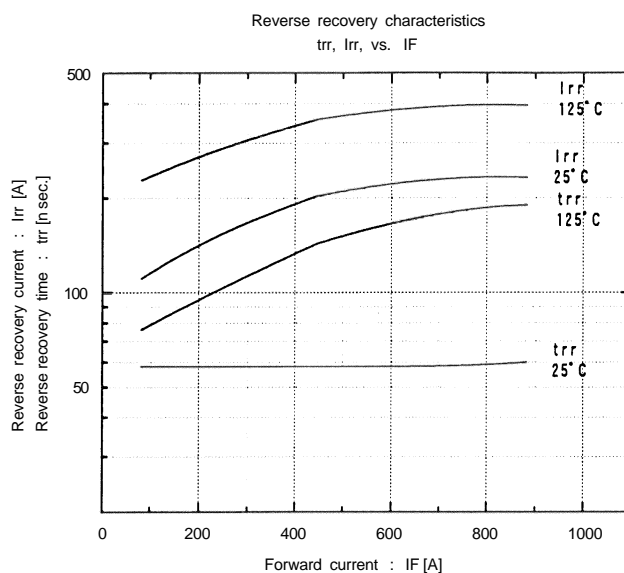
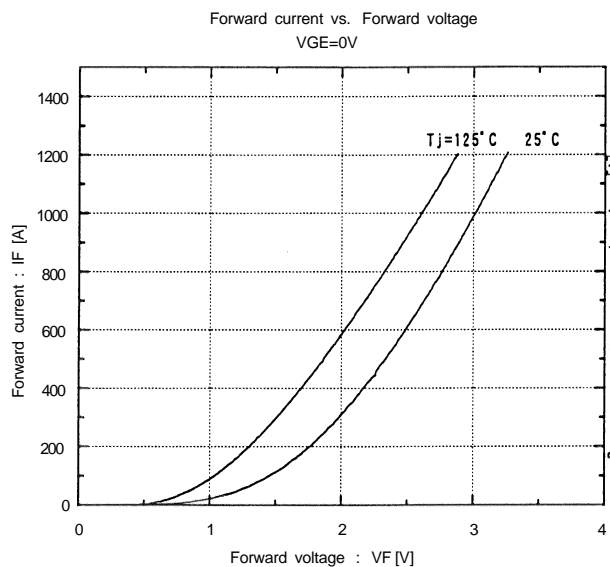
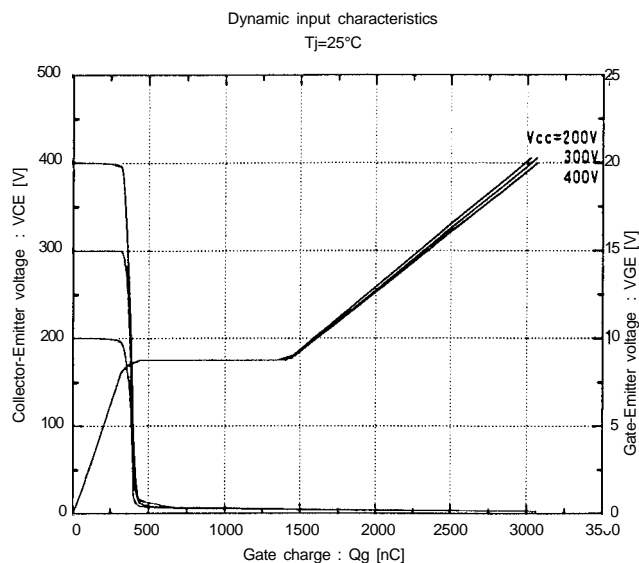
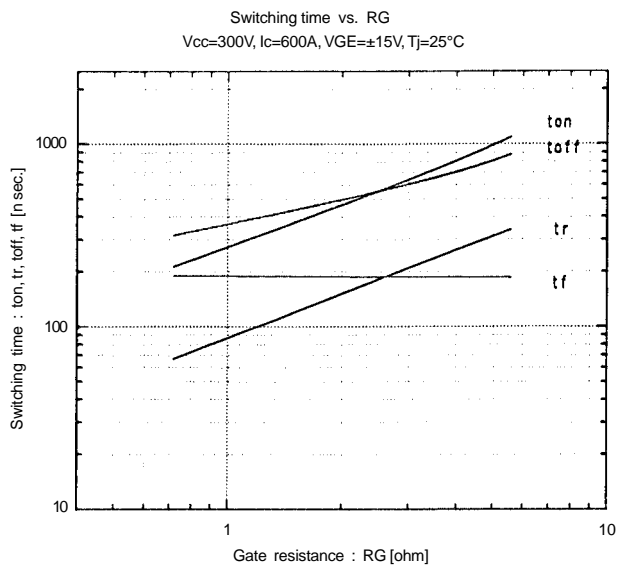

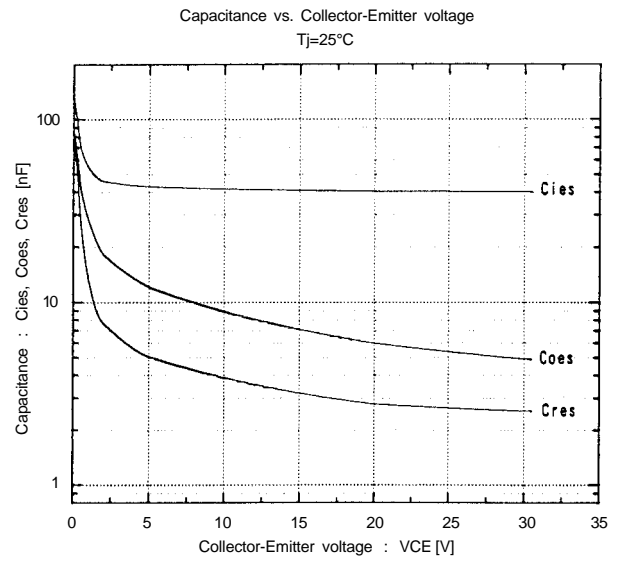
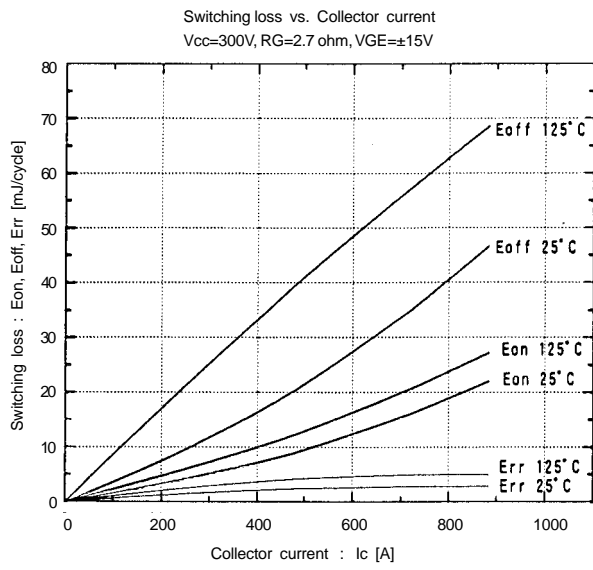

■ Outline Drawings, mm

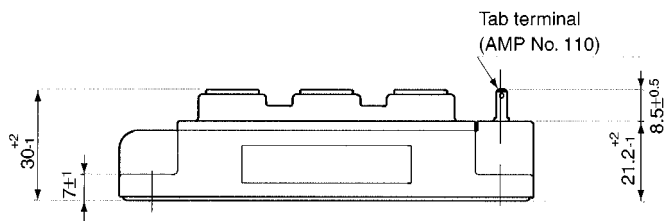
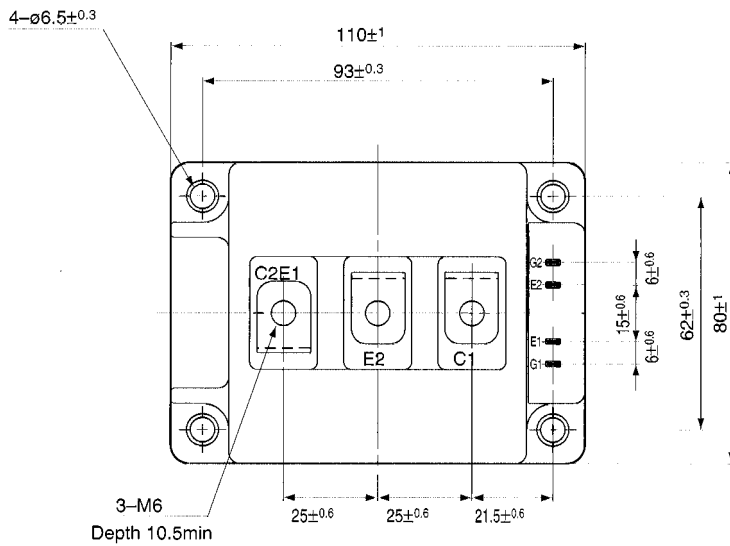

Mass: 470g