



## 3D SURROUND AUDIO PROCESSOR

### ■ GENERAL DESCRIPTION

The **NJM2702** is a 3D surround audio processor regenerating the 3D surround sound with only two speakers.

The **NJM2702** is suitable for audio applications, which are speaker system for mini components, CD radio cassette, multimedia speaker systems, TV and others.

### ■ PACKAGE OUTLINE

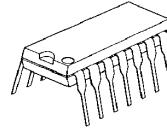

**NJM2702D**

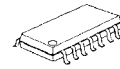

**NJM2702M**



**NJM2702V**

### ■ FEATURES

- Operating Voltage (4.7 to 13V)
- Stereo mode
  - Stable center image with natural sound field
  - High quality Surround
  - Free speaker interval
- Surround control
- Internal Mode Control Switch
- Bipolar Technology
- Package Outline DIP14, DMP14, SSOP10

### ■ BLOCK DIAGRAM

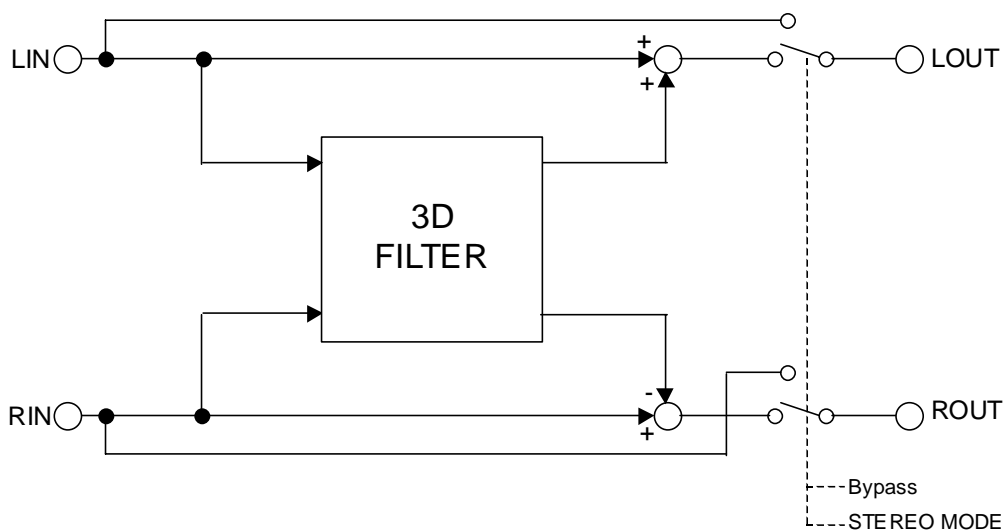

# NJM2702

## ■ABSOLUTE MAXIMUM RATING (Ta=25°C)

PARAMETER	SYMBOL	RATINGS	UNIT
Supply Voltage	V <sup>+</sup>	14	V
Power Dissipation	P <sub>D</sub>	(DIP14) 500 (DMP14) 350 (SSOP10) 250	mW
Operating Temperature Range	T <sub>opr</sub>	-40 to +85	°C
Storage Temperature Range	T <sub>stg</sub>	-40 to +125	°C

## ■OPERATING VOLTAGE

PARAMETER	SYMBOL	TEST CONDITION	MIN.	TYP.	MAX.	UNIT
Operating Voltage	V <sup>+</sup>	-	4.7	12.0	13.0	V

## ■ELECTRICAL CHARACTERISTICS (V<sup>+</sup>=12V, Ta=25°C unless otherwise specified)

PARAMETER	SYMBOL	TEST CONDITION					MIN.	TYP.	MAX.	UNIT	
		INPUT		OUTPUT	MODE	VR					
		L	R								
Operating Current	I <sub>cc</sub>	No Signal	0	0	-	BYPASS	-	3.0	6.0	9.0	mA
			0	0	-	Stereo	MAX	3.0	6.0	9.0	

## ●AC CHARACTERISTICS

(V<sup>+</sup>=12V, Ta=25°C, V<sub>IN</sub>=-10dBV(316mVrms), f=1kHz, RL=4.7kΩ, unless otherwise specified)

PARAMETER	SYMBOL	TEST CONDITION					MIN.	TYP.	MAX.	UNIT	
		INPUT		OUTPUT	MODE	VR					
		L	R								
Maximum Input Voltage	V <sub>IM</sub>	f=1kHz T.H.D.=3%	V <sub>IN</sub> 0	0 V <sub>IN</sub>	L R	BYPASS	-	9.9 (3.1)	11.9 (3.9)	-	dBV (Vrms)
		f=100Hz T.H.D.=3%	V <sub>IN</sub> 0	0 V <sub>IN</sub>	L R	Stereo	MAX	-3.8 (0.6)	-1.8 (0.8)	-	
Output Noise	V <sub>NO</sub>	R <sub>g</sub> =0Ω A-Weighted	0	0	L R	BYPASS	-	-	-112 (2.5)	-106 (5.0)	dBV (μVrms)
		R <sub>g</sub> =0Ω A-Weighted	0	0	L R	Stereo	MAX	-	-100 (10)	-94 (20)	
Total Harmonic Distortion	T.H.D	f=1kHz	V <sub>IN</sub> 0	0 V <sub>IN</sub>	L R	BYPASS	-	-	0.005	0.01	%
		f=1kHz Vin=-20dBV	V <sub>IN</sub> 0	0 V <sub>IN</sub>	L R	Stereo	MAX	-	0.1	0.5	
Bypass Gain	G <sub>VBYP</sub>	f=1kHz	V <sub>IN</sub> 0	0 V <sub>IN</sub>	L R	BYPASS	-	-1.0	0.0	1.0	dB

## ●AC CHARACTERISTICS

( $V_+ = 12V, T_a = 25^\circ C, V_{IN} = -10dBV(316mV_{rms}), f = 1kHz, R_L = 4.7k\Omega$ , unless otherwise specified)

PARAMETER	SYMBOL	TEST CONDITION						MIN.	TYP.	MAX.	UNIT
		INPUT		OUTPUT	MODE	VR					
		L	R								
Surround Gain	$G_{VSUR}$	$f = 100Hz$ $V_{in} = -20dBV$	$V_{IN}$ 0	0 $V_{IN}$	L R	Stereo	MAX	10.7	12.7	14.7	dB
		$f = 100Hz$ $V_{in} = -20dBV$	0 $V_{IN}$	$V_{IN}$ 0	L R	Stereo	MAX	8.4	10.4	12.4	
		$f = 100Hz$ $V_{in} = -20dBV$	$V_{IN}$ 0	0 $V_{IN}$	L R	Stereo	MIN	3.6	5.6	7.6	

## ●CONTROL CHARACTERISTICS ( $V_+ = 12V, T_a = 25^\circ C$ unless otherwise specified)

PARAMETER	SYMBOL	TEST CONDITION						MIN.	TYP.	MAX.	UNIT
		INPUT		OUTPUT	MODE	VR					
		L	R								
Mode Select Control Voltage	$V_{MODE}$	$V_{IN} =$ High Level	-	-	-	-	-	2.0	-	$V_+$	V
		$V_{IN} =$ Low Level	-	-	-	-	-	0.0	-	0.7	



## ■MODE SWITCH

MODE	SW	NOTES
BYPASS	L	Input Through
Stereo	H	Surround Mode (Stereo Input)

# NJM2702

## ■ TERMINAL DESCRIPTION

PIN NO.		SYMBOL	FUNCTION	EQUIVALENT CIRCUIT	VOLTAGE
DIP14 DMP14	SSOP10				
1	1	FIL	Filter Input		$V+/2$
2 4 8 10	-	NC	Test pin		
3	2	VOL	Surround VR		$V+/2$
5	3	VREFIN	Reference Voltage Input		$V+/2$

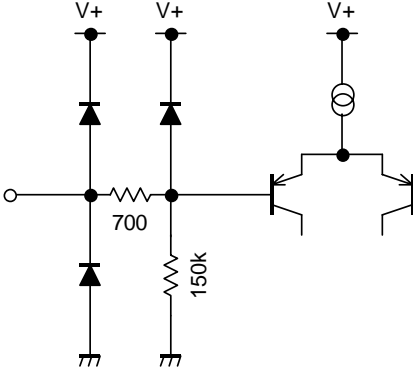
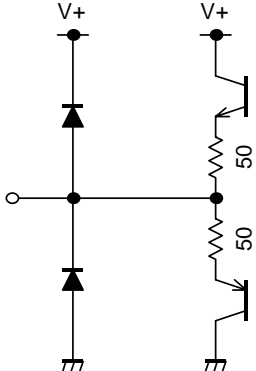
PIN NO.		SYMBOL	FUNCTION	EQUIVALENT CIRCUIT	VOLTAGE
DIP14 DMP14	SSOP10				
6	4	V+	Power Supply		V+
7	5	GND	GND		0V
9	6	SW	Mode Control Switch		0V
11 12	7 8	ROUT LOUT	Rch Output Lch Output		V+/2

# NJM2702

PIN NO.		SYMBOL	FUNCTION	EQUIVALENT CIRCUIT	VOLTAGE
DIP14 DMP14	SSOP10				
13 14	9 10	RIN LIN	Rch Input Lch Input		V+/2

## APPLICATION CIRCUIT

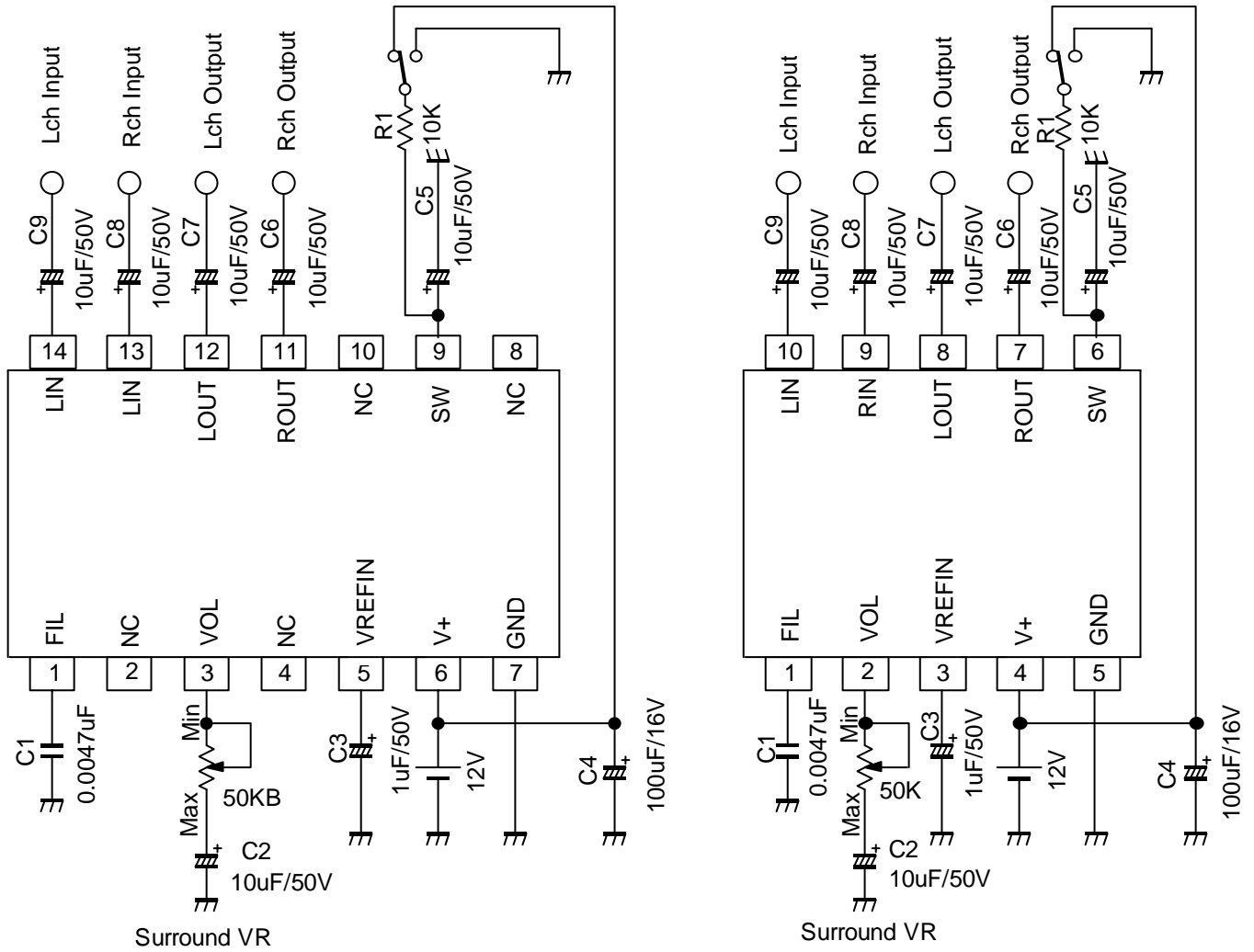

Parts No.	Value	Tolerance	Parts No.	Value	Tolerance
R1	10kΩ	5%	C3	1μF	20%
C1	0.0047μF	5%	C4	100μF	20%
C2,C5,C6,C7,C8,C9	10μF	20%			

# NJM2702

## TYPICAL CHARACTERISTICS

Supply Current vs Supply Voltage

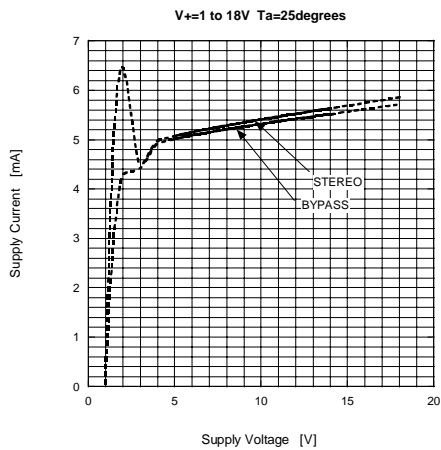

Supply Current vs Ambient Temperature

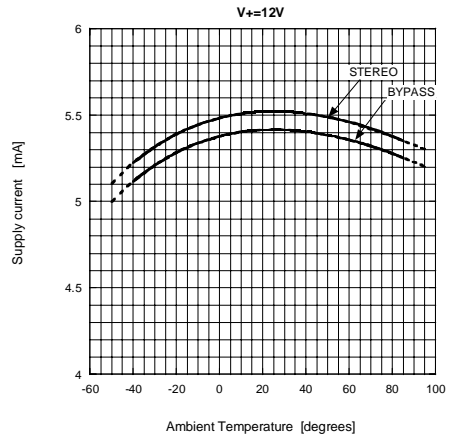

Maximum Input Voltage vs Supply Voltage (BYPASS)

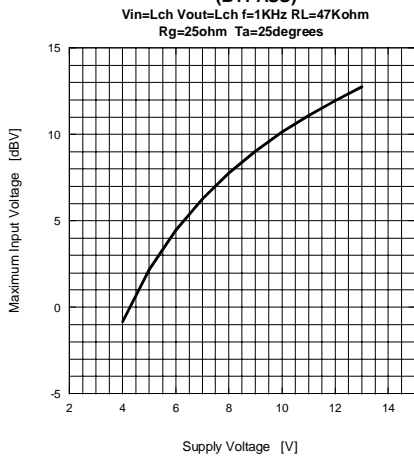

Maximum Input Voltage vs Supply Voltage (STEREO)

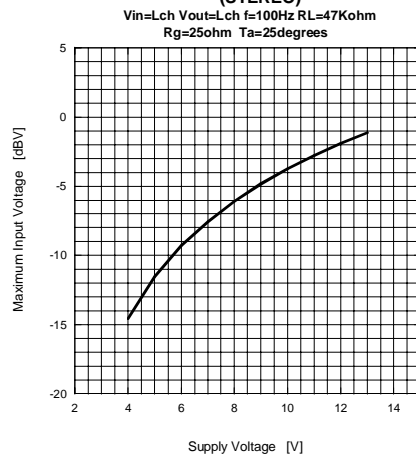

Output Noise vs Ambient Temperature

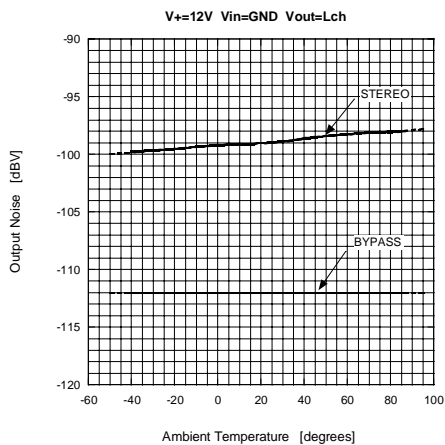

Output Noise vs Ambient Temperature

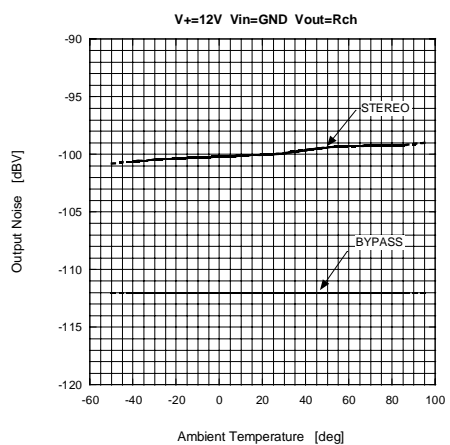



## TYPICAL CHARACTERISTICS

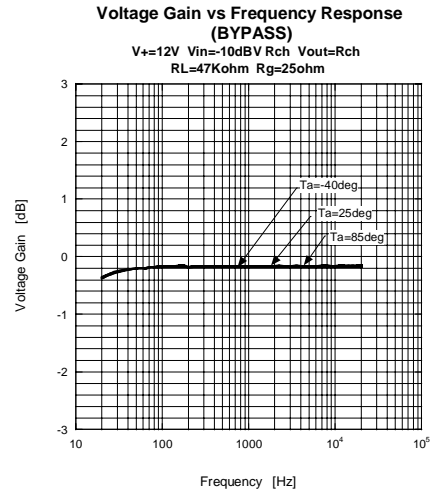
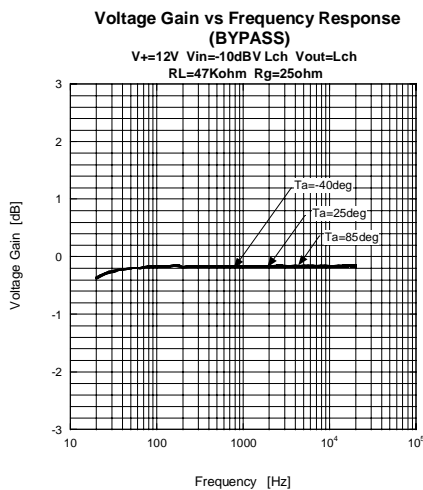
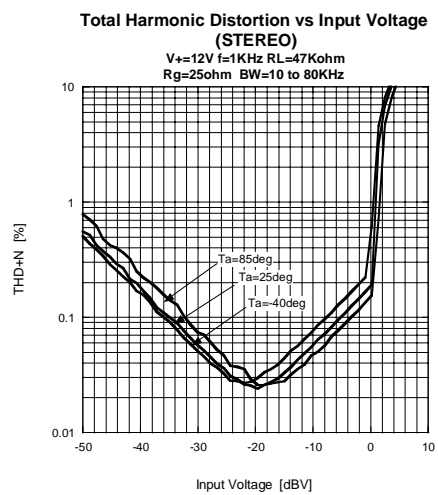
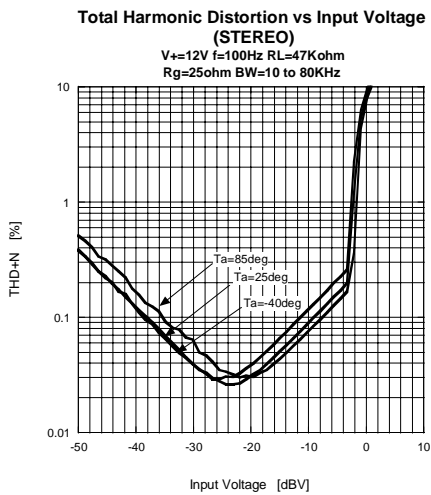
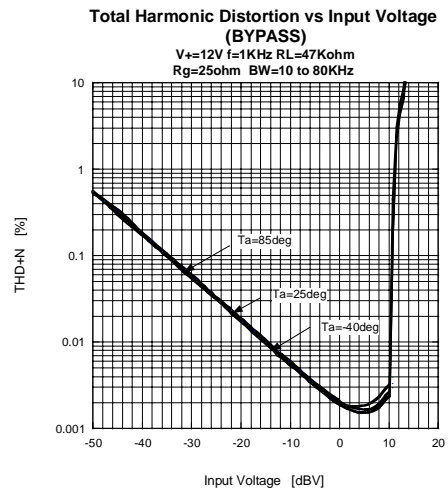
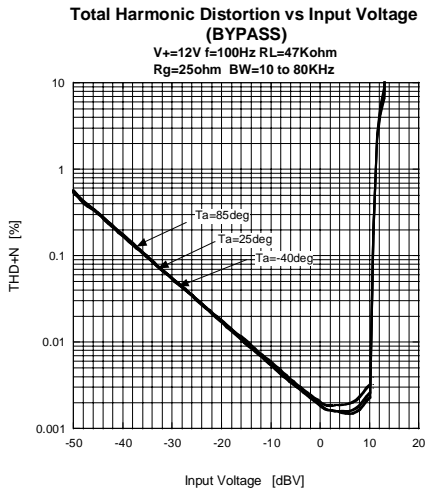

## TYPICAL CHARACTERISTICS

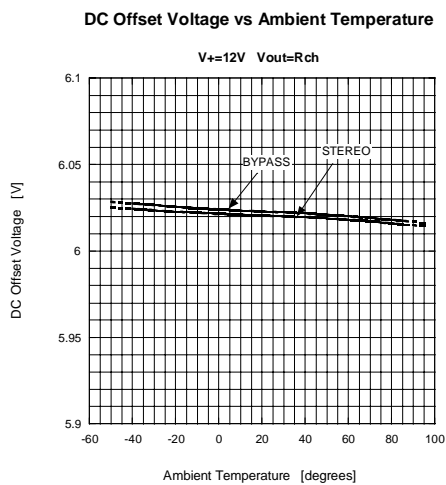
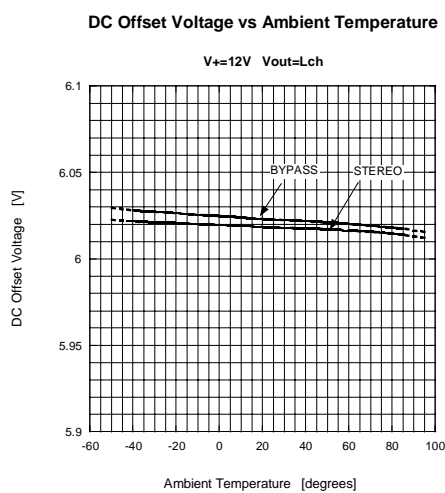
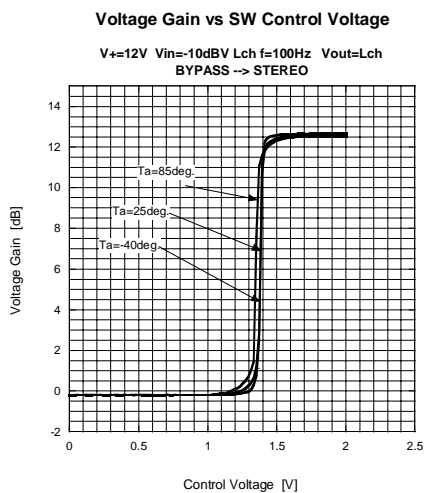
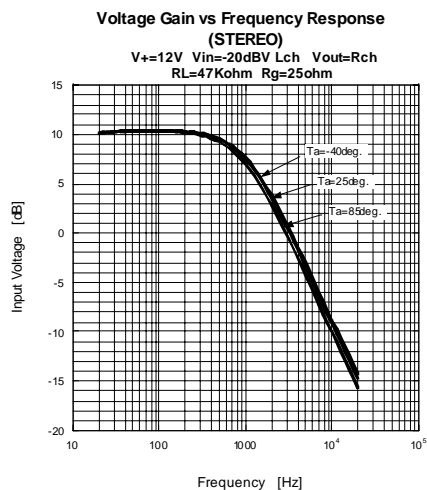
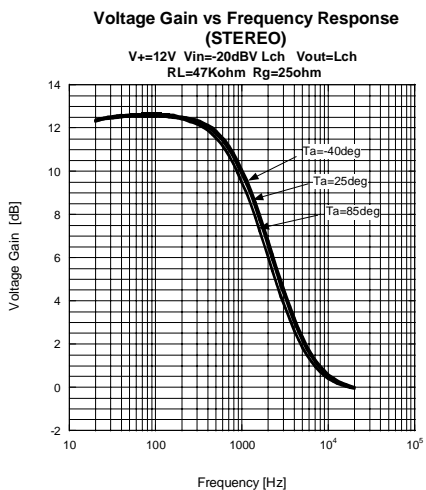

**[CAUTION]**  
 The specifications on this databook are only given for information, without any guarantee as regards either mistakes or omissions. The application circuits in this databook are described only to show representative usages of the product and not intended for the guarantee or permission of any right including the industrial rights.