

MMBT2222LT1, MMBT2222ALT1

MMBT2222ALT1 is a Preferred Device

General Purpose Transistors

NPN Silicon

Features

- Pb-Free Package May be Available. The G-Suffix Denotes a Pb-Free Lead Finish

MAXIMUM RATINGS

Rating	Symbol	Value	Unit
Collector-Emitter Voltage MMBT2222LT1 MMBT2222ALT1	V_{CEO}	30 40	Vdc
Collector-Base Voltage MMBT2222LT1 MMBT2222ALT1	V_{CBO}	60 75	Vdc
Emitter-Base Voltage MMBT2222LT1 MMBT2222ALT1	V_{EBO}	5.0 6.0	Vdc
Collector Current - Continuous	I_C	600	mAdc

THERMAL CHARACTERISTICS

Characteristic	Symbol	Max	Unit
Total Device Dissipation FR-5 Board (Note 1) $T_A = 25^\circ\text{C}$ Derate above 25°C	P_D	225 1.8	mW mW/ $^\circ\text{C}$
Thermal Resistance Junction-to-Ambient	$R_{\theta JA}$	556	$^\circ\text{C}/\text{W}$
Total Device Dissipation Alumina Substrate (Note 2) $T_A = 25^\circ\text{C}$ Derate above 25°C	P_D	300 2.4	mW mW/ $^\circ\text{C}$
Thermal Resistance Junction-to-Ambient	$R_{\theta JA}$	417	$^\circ\text{C}/\text{W}$
Junction and Storage Temperature Range	T_J, T_{stg}	-55 to +150	$^\circ\text{C}$

Maximum ratings are those values beyond which device damage can occur. Maximum ratings applied to the device are individual stress limit values (not normal operating conditions) and are not valid simultaneously. If these limits are exceeded, device functional operation is not implied, damage may occur and reliability may be affected.

- FR-5 = $1.0 \times 0.75 \times 0.062$ in.
- Alumina = $0.4 \times 0.3 \times 0.024$ in. 99.5% alumina.



ON Semiconductor®

<http://onsemi.com>

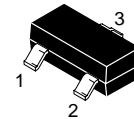
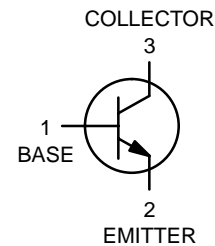

SOT-23
CASE 318
Style 6

MARKING DIAGRAM

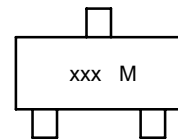

xxx = Specific Device Code
(M1B = MMBT2222LT1,
1P = MMBT2222ALT1)
M = Date Code

ORDERING INFORMATION

Device	Package	Shipping†
MMBT2222LT1	SOT-23	3000/Tape & Reel
MMBT2222LT1G	SOT-23 (Pb-Free)	3000/Tape & Reel
MMBT2222ALT1	SOT-23	3000/Tape & Reel
MMBT2222ALT1G	SOT-23 (Pb-Free)	3000/Tape & Reel
MMBT2222LT3	SOT-23	10,000/Tape & Reel
MMBT2222ALT3	SOT-23	10,000/Tape & Reel
MMBT2222ALT3G	SOT-23 (Pb-Free)	10,000/Tape & Reel

†For information on tape and reel specifications, including part orientation and tape sizes, please refer to our Tape and Reel Packaging Specifications Brochure, BRD8011/D.

Preferred devices are recommended choices for future use and best overall value.

MMBT2222LT1, MMBT2222ALT1

ELECTRICAL CHARACTERISTICS ($T_A = 25^\circ\text{C}$ unless otherwise noted)

Characteristic	Symbol	Min	Max	Unit	
OFF CHARACTERISTICS					
Collector–Emitter Breakdown Voltage ($I_C = 10\text{ mAdc}$, $I_E = 0$)	MMBT2222 MMBT2222A	$V_{(BR)CEO}$	30 40	– –	Vdc
Collector–Base Breakdown Voltage ($I_C = 10\text{ }\mu\text{Adc}$, $I_E = 0$)	MMBT2222 MMBT2222A	$V_{(BR)CBO}$	60 75	– –	Vdc
Emitter–Base Breakdown Voltage ($I_E = 10\text{ }\mu\text{Adc}$, $I_C = 0$)	MMBT2222 MMBT2222A	$V_{(BR)EBO}$	5.0 6.0	– –	Vdc
Collector Cutoff Current ($V_{CE} = 60\text{ Vdc}$, $V_{EB(off)} = 3.0\text{ Vdc}$)	MMBT2222A	I_{CEX}	–	10	nAdc
Collector Cutoff Current ($V_{CB} = 50\text{ Vdc}$, $I_E = 0$)	MMBT2222 MMBT2222A	I_{CBO}	–	0.01	μAdc
($V_{CB} = 60\text{ Vdc}$, $I_E = 0$)	MMBT2222A		–	0.01	
($V_{CB} = 50\text{ Vdc}$, $I_E = 0$, $T_A = 125^\circ\text{C}$)	MMBT2222		–	10	
($V_{CB} = 60\text{ Vdc}$, $I_E = 0$, $T_A = 125^\circ\text{C}$)	MMBT2222A		–	10	
Emitter Cutoff Current ($V_{EB} = 3.0\text{ Vdc}$, $I_C = 0$)	MMBT2222A	I_{EBO}	–	100	nAdc
Base Cutoff Current ($V_{CE} = 60\text{ Vdc}$, $V_{EB(off)} = 3.0\text{ Vdc}$)	MMBT2222A	I_{BL}	–	20	nAdc

ON CHARACTERISTICS

DC Current Gain ($I_C = 0.1\text{ mAdc}$, $V_{CE} = 10\text{ Vdc}$) ($I_C = 1.0\text{ mAdc}$, $V_{CE} = 10\text{ Vdc}$) ($I_C = 10\text{ mAdc}$, $V_{CE} = 10\text{ Vdc}$) ($I_C = 10\text{ mAdc}$, $V_{CE} = 10\text{ Vdc}$, $T_A = -55^\circ\text{C}$) ($I_C = 150\text{ mAdc}$, $V_{CE} = 10\text{ Vdc}$) (Note 3) ($I_C = 150\text{ mAdc}$, $V_{CE} = 1.0\text{ Vdc}$) (Note 3) ($I_C = 500\text{ mAdc}$, $V_{CE} = 10\text{ Vdc}$) (Note 3)	MMBT2222A only MMBT2222 MMBT2222A	h_{FE}	35 50 75 35 100 50 30 40	– – – – 300 – – –	–
Collector–Emitter Saturation Voltage (Note 3) ($I_C = 150\text{ mAdc}$, $I_B = 15\text{ mAdc}$) ($I_C = 500\text{ mAdc}$, $I_B = 50\text{ mAdc}$)	MMBT2222 MMBT2222A MMBT2222 MMBT2222A	$V_{CE(sat)}$	– – – –	0.4 0.3 1.6 1.0	Vdc
Base–Emitter Saturation Voltage (Note 3) ($I_C = 150\text{ mAdc}$, $I_B = 15\text{ mAdc}$) ($I_C = 500\text{ mAdc}$, $I_B = 50\text{ mAdc}$)	MMBT2222 MMBT2222A MMBT2222 MMBT2222A	$V_{BE(sat)}$	– 0.6 – –	1.3 1.2 2.6 2.0	Vdc

SMALL–SIGNAL CHARACTERISTICS

Current–Gain–Bandwidth Product (Note 4) ($I_C = 20\text{ mAdc}$, $V_{CE} = 20\text{ Vdc}$, $f = 100\text{ MHz}$)	MMBT2222 MMBT2222A	f_T	250 300	– –	MHz
Output Capacitance ($V_{CB} = 10\text{ Vdc}$, $I_E = 0$, $f = 1.0\text{ MHz}$)		C_{obo}	–	8.0	pF
Input Capacitance ($V_{EB} = 0.5\text{ Vdc}$, $I_C = 0$, $f = 1.0\text{ MHz}$)	MMBT2222 MMBT2222A	C_{ibo}	– –	30 25	pF
Input Impedance ($I_C = 1.0\text{ mAdc}$, $V_{CE} = 10\text{ Vdc}$, $f = 1.0\text{ kHz}$) ($I_C = 10\text{ mAdc}$, $V_{CE} = 10\text{ Vdc}$, $f = 1.0\text{ kHz}$)	MMBT2222A MMBT2222A	h_{ie}	2.0 0.25	8.0 1.25	$k\Omega$
Voltage Feedback Ratio ($I_C = 1.0\text{ mAdc}$, $V_{CE} = 10\text{ Vdc}$, $f = 1.0\text{ kHz}$) ($I_C = 10\text{ mAdc}$, $V_{CE} = 10\text{ Vdc}$, $f = 1.0\text{ kHz}$)	MMBT2222A MMBT2222A	h_{re}	– –	8.0 4.0	$\times 10^{-4}$
Small–Signal Current Gain ($I_C = 1.0\text{ mAdc}$, $V_{CE} = 10\text{ Vdc}$, $f = 1.0\text{ kHz}$) ($I_C = 10\text{ mAdc}$, $V_{CE} = 10\text{ Vdc}$, $f = 1.0\text{ kHz}$)	MMBT2222A MMBT2222A	h_{fe}	50 75	300 375	–

3. Pulse Test: Pulse Width $\leq 300\text{ }\mu\text{s}$, Duty Cycle $\leq 2.0\%$.

4. f_T is defined as the frequency at which $|h_{fe}|$ extrapolates to unity.

MMBT2222LT1, MMBT2222ALT1

ELECTRICAL CHARACTERISTICS ($T_A = 25^\circ\text{C}$ unless otherwise noted)

Characteristic	Symbol	Min	Max	Unit	
SMALL-SIGNAL CHARACTERISTICS					
Output Admittance ($I_C = 1.0\text{ mA}$, $V_{CE} = 10\text{ Vdc}$, $f = 1.0\text{ kHz}$) ($I_C = 10\text{ mA}$, $V_{CE} = 10\text{ Vdc}$, $f = 1.0\text{ kHz}$)	MMBT2222A MMBT2222A	h_{oe}	5.0 25	35 200	μhos
Collector Base Time Constant ($I_E = 20\text{ mA}$, $V_{CB} = 20\text{ Vdc}$, $f = 31.8\text{ MHz}$)	MMBT2222A	r_b, C_c	-	150	ps
Noise Figure ($I_C = 100\text{ }\mu\text{A}$, $V_{CE} = 10\text{ Vdc}$, $R_S = 1.0\text{ k}\Omega$, $f = 1.0\text{ kHz}$)	MMBT2222A	NF	-	4.0	dB

SWITCHING CHARACTERISTICS (MMBT2222A only)

Delay Time	($V_{CC} = 30\text{ Vdc}$, $V_{BE(\text{off})} = -0.5\text{ Vdc}$, $I_C = 150\text{ mA}$, $I_{B1} = 15\text{ mA}$)	t_d	-	10	ns
Rise Time		t_r	-	25	
Storage Time	($V_{CC} = 30\text{ Vdc}$, $I_C = 150\text{ mA}$, $I_{B1} = I_{B2} = 15\text{ mA}$)	t_s	-	225	ns
Fall Time		t_f	-	60	

- Pulse Test: Pulse Width $\leq 300\text{ }\mu\text{s}$, Duty Cycle $\leq 2.0\%$.
- t_f is defined as the frequency at which $|h_{fe}|$ extrapolates to unity.

SWITCHING TIME EQUIVALENT TEST CIRCUITS

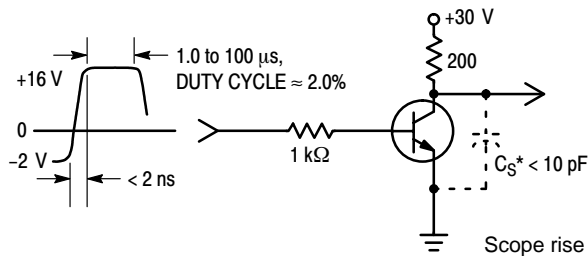

Figure 1. Turn-On Time

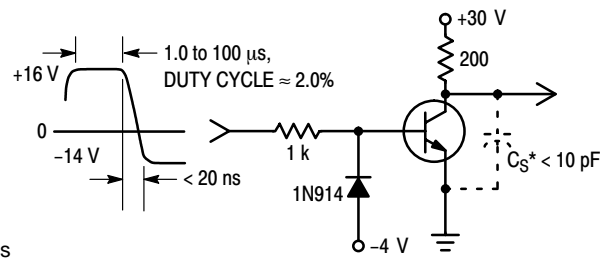

Figure 2. Turn-Off Time

MMBT2222LT1, MMBT2222ALT1

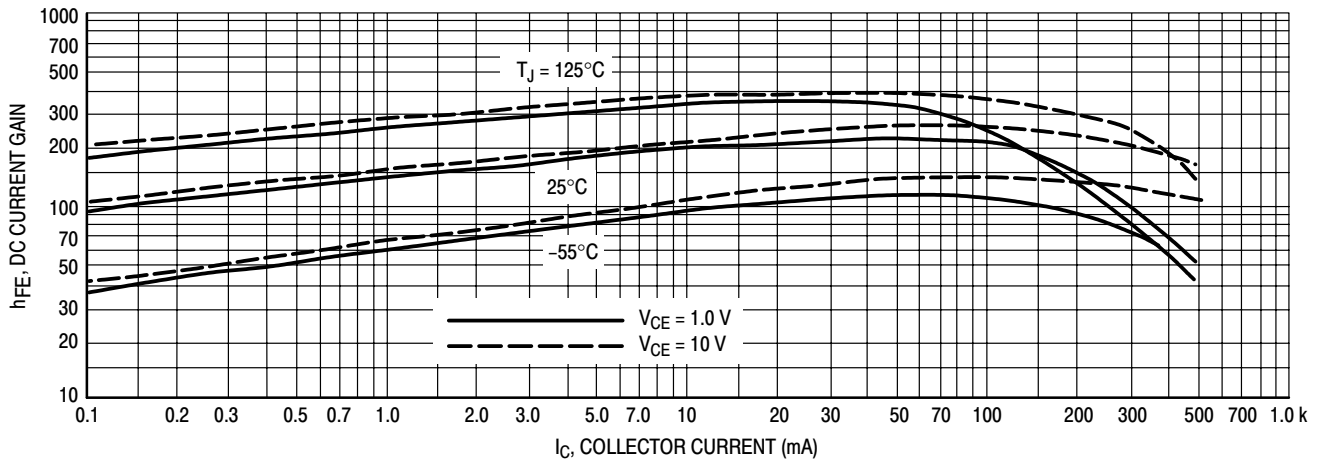

Figure 3. DC Current Gain

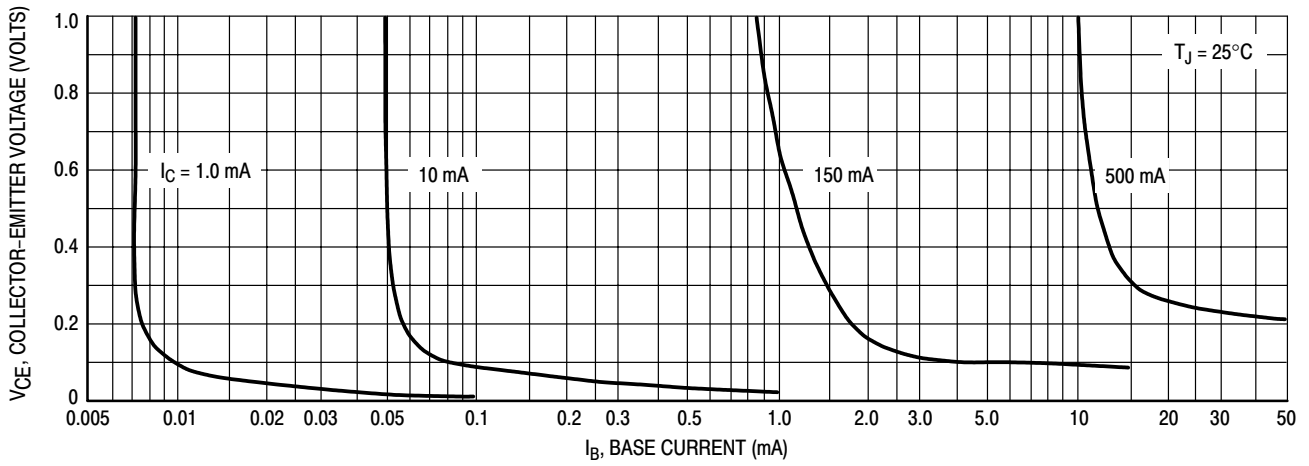

Figure 4. Collector Saturation Region

MMBT2222LT1, MMBT2222ALT1

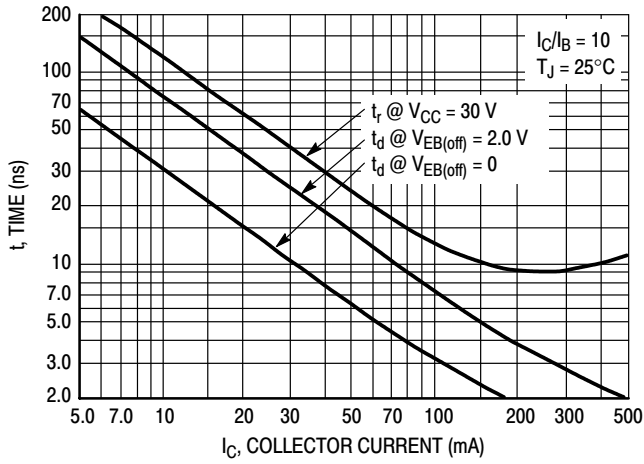

Figure 5. Turn-On Time

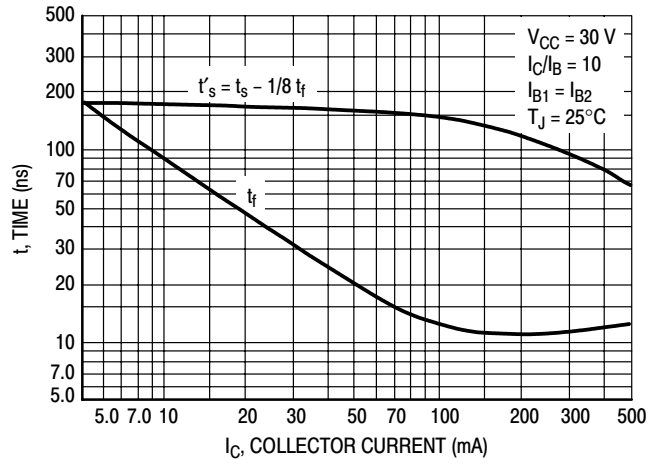

Figure 6. Turn-Off Time

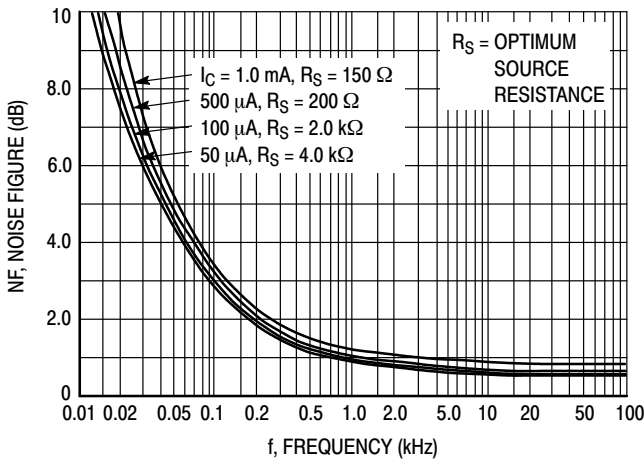

Figure 7. Frequency Effects

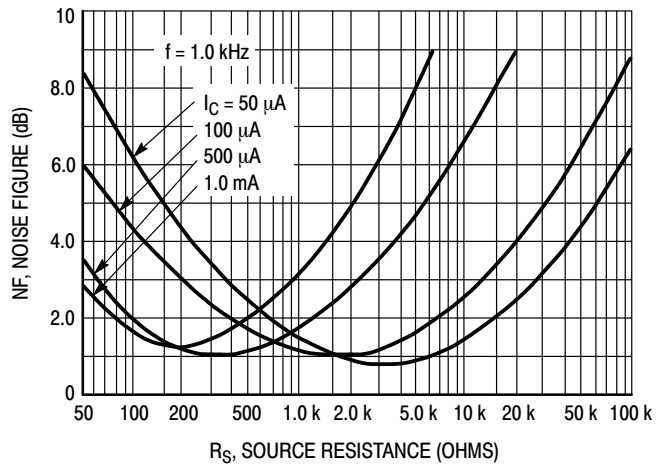

Figure 8. Source Resistance Effects

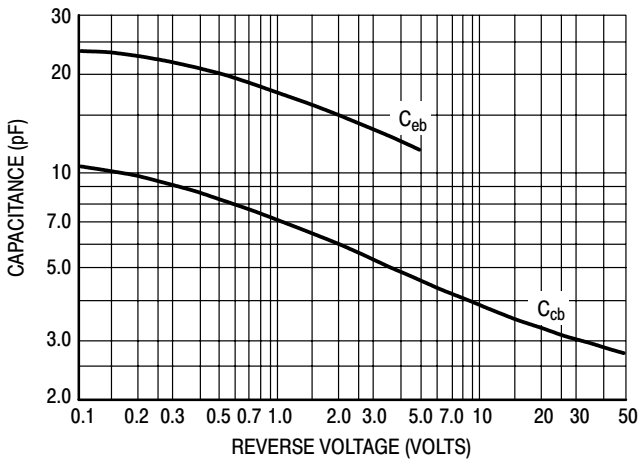

Figure 9. Capacitances

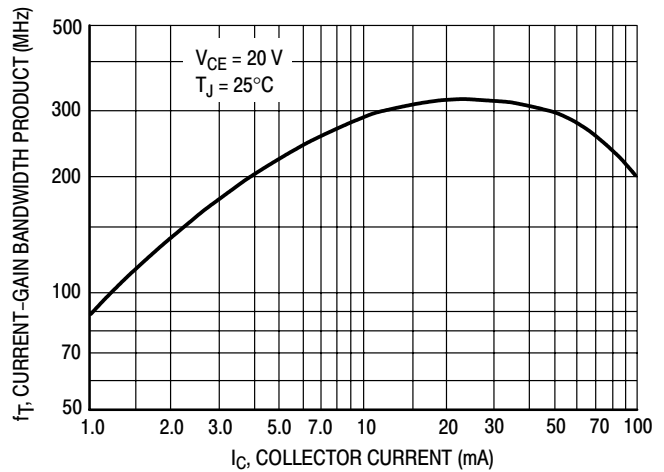

Figure 10. Current-Gain Bandwidth Product

MMBT2222LT1, MMBT2222ALT1

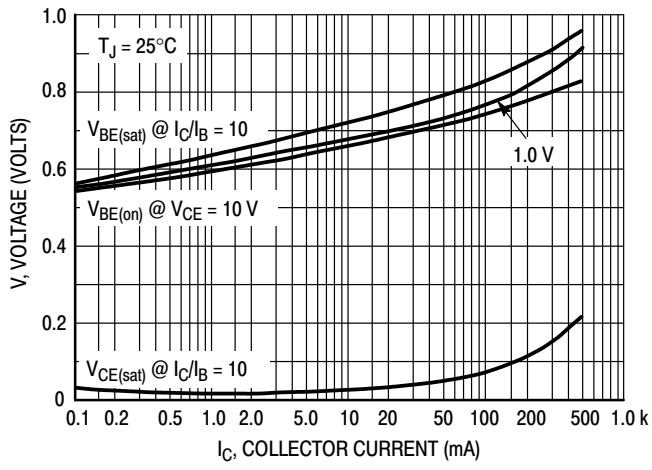

Figure 11. "On" Voltages

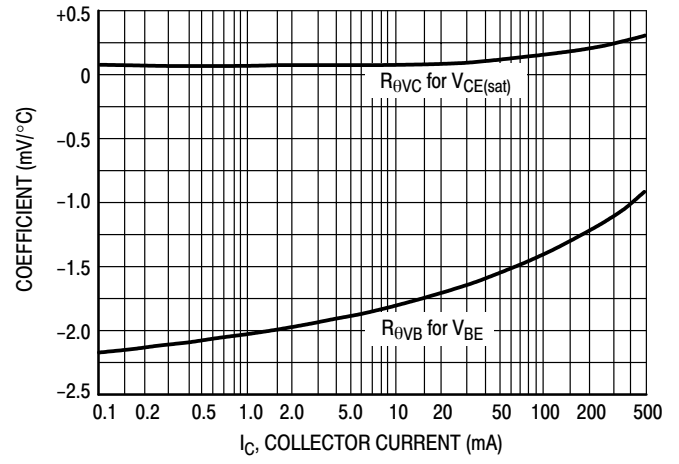
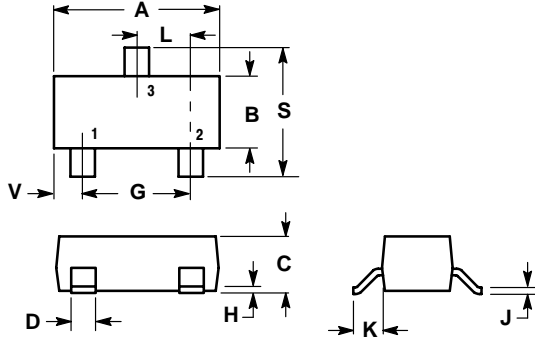

Figure 12. Temperature Coefficients

MMBT2222LT1, MMBT2222ALT1

PACKAGE DIMENSIONS

SOT-23 (TO-236AB)
CASE 318-08
ISSUE AH



NOTES:

1. DIMENSIONING AND TOLERANCING PER ANSI Y14.5M, 1982.
2. CONTROLLING DIMENSION: INCH.
3. MAXIMUM LEAD THICKNESS INCLUDES LEAD FINISH THICKNESS. MINIMUM LEAD THICKNESS IS THE MINIMUM THICKNESS OF BASE MATERIAL.
4. 318-03 AND -07 OBSOLETE, NEW STANDARD 318-08.

DIM	INCHES		MILLIMETERS	
	MIN	MAX	MIN	MAX
A	0.1102	0.1197	2.80	3.04
B	0.0472	0.0551	1.20	1.40
C	0.0350	0.0440	0.89	1.11
D	0.0150	0.0200	0.37	0.50
G	0.0701	0.0807	1.78	2.04
H	0.0005	0.0040	0.013	0.100
J	0.0034	0.0070	0.085	0.177
K	0.0140	0.0285	0.35	0.69
L	0.0350	0.0401	0.89	1.02
S	0.0830	0.1039	2.10	2.64
V	0.0177	0.0236	0.45	0.60

STYLE 6:

- PIN 1. BASE
2. EMITTER
3. COLLECTOR

SOLDERING FOOTPRINT*

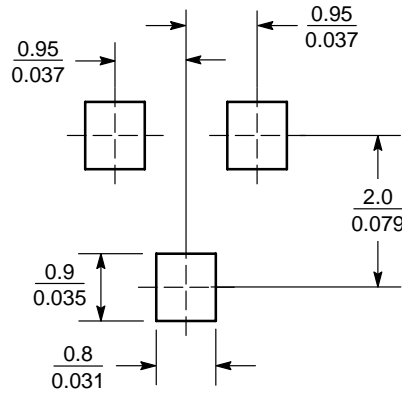

*For additional information on our Pb-Free strategy and soldering details, please download the ON Semiconductor Soldering and Mounting Techniques Reference Manual, SOLDERRM/D.

MMBT2222LT1, MMBT2222ALT1

ON Semiconductor and  are registered trademarks of Semiconductor Components Industries, LLC (SCILLC). SCILLC reserves the right to make changes without further notice to any products herein. SCILLC makes no warranty, representation or guarantee regarding the suitability of its products for any particular purpose, nor does SCILLC assume any liability arising out of the application or use of any product or circuit, and specifically disclaims any and all liability, including without limitation special, consequential or incidental damages. "Typical" parameters which may be provided in SCILLC data sheets and/or specifications can and do vary in different applications and actual performance may vary over time. All operating parameters, including "Typicals" must be validated for each customer application by customer's technical experts. SCILLC does not convey any license under its patent rights nor the rights of others. SCILLC products are not designed, intended, or authorized for use as components in systems intended for surgical implant into the body, or other applications intended to support or sustain life, or for any other application in which the failure of the SCILLC product could create a situation where personal injury or death may occur. Should Buyer purchase or use SCILLC products for any such unintended or unauthorized application, Buyer shall indemnify and hold SCILLC and its officers, employees, subsidiaries, affiliates, and distributors harmless against all claims, costs, damages, and expenses, and reasonable attorney fees arising out of, directly or indirectly, any claim of personal injury or death associated with such unintended or unauthorized use, even if such claim alleges that SCILLC was negligent regarding the design or manufacture of the part. SCILLC is an Equal Opportunity/Affirmative Action Employer. This literature is subject to all applicable copyright laws and is not for resale in any manner.

PUBLICATION ORDERING INFORMATION

LITERATURE FULFILLMENT:

Literature Distribution Center for ON Semiconductor
P.O. Box 61312, Phoenix, Arizona 85082-1312 USA
Phone: 480-829-7710 or 800-344-3860 Toll Free USA/Canada
Fax: 480-829-7709 or 800-344-3867 Toll Free USA/Canada
Email: orderlit@onsemi.com

N. American Technical Support: 800-282-9855 Toll Free
USA/Canada

Japan: ON Semiconductor, Japan Customer Focus Center
2-9-1 Kamimeguro, Meguro-ku, Tokyo, Japan 153-0051
Phone: 81-3-5773-3850

ON Semiconductor Website: <http://onsemi.com>

Order Literature: <http://www.onsemi.com/litorder>

For additional information, please contact your
local Sales Representative.