

# Technische Information / Technical Information

IGBT-Module  
IGBT-Modules

## FP50R12KE3

eupec

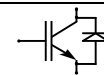

Vorläufige Daten  
Preliminary data

### Elektrische Eigenschaften / Electrical properties

#### Höchstzulässige Werte / Maximum rated values

##### Diode Gleichrichter/ Diode Rectifier

Periodische Rückw. Spitzensperrspannung repetitive peak reverse voltage		$V_{RRM}$	1600	V
Gleichrichter Ausgang Grenzeffektivstrom maximum RMS current at Rectifier output		$I_{RMSmax}$	t.b.d.	A
Dauergleichstrom DC forward current	$T_C = 80^\circ\text{C}$	$I_d$	50	A
Stoßstrom Grenzwert surge forward current	$t_p = 10\text{ ms}, T_{vj} = 25^\circ\text{C}$	$I_{FSM}$	500	A
	$t_p = 10\text{ ms}, T_{vj} = 150^\circ\text{C}$		400	A
Grenzlastintegral $I^2t$ - value	$t_p = 10\text{ ms}, T_{vj} = 25^\circ\text{C}$	$I^2t$	1250	$\text{A}^2\text{s}$
	$t_p = 10\text{ ms}, T_{vj} = 150^\circ\text{C}$		800	$\text{A}^2\text{s}$

##### Transistor Wechselrichter/ Transistor Inverter

Kollektor-Emitter-Sperrspannung collector-emitter voltage		$V_{CES}$	1200	V
Kollektor-Dauergleichstrom DC-collector current	$T_C = 80^\circ\text{C}$	$I_{C,nom.}$ $I_C$	50	A
	$T_C = 25^\circ\text{C}$		75	A
Periodischer Kollektor Spitzenstrom repetitive peak collector current	$t_p = 1\text{ ms}, T_C = 80^\circ\text{C}$	$I_{CRM}$	100	A
Gesamt-Verlustleistung total power dissipation	$T_C = 25^\circ\text{C}$	$P_{tot}$	270	W
Gate-Emitter-Spitzenspannung gate-emitter peak voltage		$V_{GES}$	+/- 20V	V

##### Diode Wechselrichter/ Diode Inverter

Dauergleichstrom DC forward current	$T_C = 80^\circ\text{C}$	$I_F$	50	A
Periodischer Spitzenstrom repetitive peak forw. current	$t_p = 1\text{ ms}$	$I_{FRM}$	100	A
Grenzlastintegral $I^2t$ - value	$V_R = 0\text{V}, t_p = 10\text{ms}, T_{vj} = 125^\circ\text{C}$	$I^2t$	690	$\text{A}^2\text{s}$

##### Transistor Brems-Chopper/ Transistor Brake-Chopper

Kollektor-Emitter-Sperrspannung collector-emitter voltage		$V_{CES}$	1200	V
Kollektor-Dauergleichstrom DC-collector current	$T_C = 80^\circ\text{C}$	$I_{C,nom.}$ $I_C$	40	A
	$T_C = 25^\circ\text{C}$		55	A
Periodischer Kollektor Spitzenstrom repetitive peak collector current	$t_p = 1\text{ ms}, T_C = 80^\circ\text{C}$	$I_{CRM}$	80	A
Gesamt-Verlustleistung total power dissipation	$T_C = 25^\circ\text{C}$	$P_{tot}$	200	W
Gate-Emitter-Spitzenspannung gate-emitter peak voltage		$V_{GES}$	+/- 20V	V

##### Diode Brems-Chopper/ Diode Brake-Chopper

Dauergleichstrom DC forward current	$T_C = 80^\circ\text{C}$	$I_F$	15	A
Periodischer Spitzenstrom repetitive peak forw. current	$t_p = 1\text{ ms}$	$I_{FRM}$	30	A

prepared by: Andreas Schulz	date of publication:06.03.2001
approved by: Hornkamp	revision: 1

# Technische Information / Technical Information

IGBT-Module  
IGBT-Modules

## FP50R12KE3

eupec

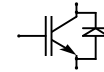

### Vorläufige Daten Preliminary data

#### Modul Isolation/ Module Isolation

Isolations-Prüfspannung insulation test voltage	RMS, f = 50 Hz, t = 1 min. NTC connected to Baseplate	V <sub>ISOL</sub>	2,5	kV
--	--	-------------------	-----	----

### Elektrische Eigenschaften / Electrical properties

#### Charakteristische Werte / Characteristic values

##### Diode Gleichrichter/ Diode Rectifier

			min.	typ.	max.	
Durchlaßspannung forward voltage	T <sub>vj</sub> = 150°C, I <sub>F</sub> = 50 A	V <sub>F</sub>	-	1,05	-	V
Schleusenspannung threshold voltage	T <sub>vj</sub> = 150°C	V <sub>(TO)</sub>	-	-	0,8	V
Ersatzwiderstand slope resistance	T <sub>vj</sub> = 150°C	r <sub>T</sub>	-	-	6,5	mΩ
Sperrstrom reverse current	T <sub>vj</sub> = 150°C, V <sub>R</sub> = 1600 V	I <sub>R</sub>	-	3	-	mA
Modul Leitungswiderstand, Anschlüsse-Chip lead resistance, terminals-chip	T <sub>C</sub> = 25°C	R <sub>AA'+CC'</sub>	-	4	-	mΩ

##### Transistor Wechselrichter/ Transistor Inverter

			min.	typ.	max.	
Kollektor-Emitter Sättigungsspannung collector-emitter saturation voltage	V <sub>GE</sub> = 15V, T <sub>vj</sub> = 25°C, I <sub>C</sub> = 50 A	V <sub>CE sat</sub>	-	1,7	2,2	V
	V <sub>GE</sub> = 15V, T <sub>vj</sub> = 125°C, I <sub>C</sub> = 50 A		-	2	-	V
Gate-Schwellenspannung gate threshold voltage	V <sub>CE</sub> = V <sub>GE</sub> , T <sub>vj</sub> = 25°C, I <sub>C</sub> = 2,0 mA	V <sub>GE(TO)</sub>	5,0	5,8	6,5	V
Eingangskapazität input capacitance	f = 1MHz, T <sub>vj</sub> = 25°C V <sub>CE</sub> = 25 V, V <sub>GE</sub> = 0 V	C <sub>ies</sub>	-	3,5	-	nF
Kollektor-Emitter Reststrom collector-emitter cut off current	V <sub>GE</sub> = 0V, T <sub>vj</sub> = 25°C, V <sub>CE</sub> = 1200 V	I <sub>CES</sub>	-	-	5	mA
Gate-Emitter Reststrom gate-emitter leakage current	V <sub>CE</sub> = 0V, V <sub>GE</sub> = 20V, T <sub>vj</sub> = 25°C	I <sub>GES</sub>	-	-	400	nA
Einschaltverzögerungszeit (ind. Last) turn on delay time (inductive load)	I <sub>C</sub> = I <sub>Nenn</sub> , V <sub>CC</sub> = 600 V	t <sub>d,on</sub>	-	85	-	ns
	V <sub>GE</sub> = ±15V, T <sub>vj</sub> = 25°C, R <sub>G</sub> = 18 Ohm					
	V <sub>GE</sub> = ±15V, T <sub>vj</sub> = 125°C, R <sub>G</sub> = 18 Ohm					
Anstiegszeit (induktive Last) rise time (inductive load)	I <sub>C</sub> = I <sub>Nenn</sub> , V <sub>CC</sub> = 600 V	t <sub>r</sub>	-	30	-	ns
	V <sub>GE</sub> = ±15V, T <sub>vj</sub> = 25°C, R <sub>G</sub> = 18 Ohm					
	V <sub>GE</sub> = ±15V, T <sub>vj</sub> = 125°C, R <sub>G</sub> = 18 Ohm					
Abschaltverzögerungszeit (ind. Last) turn off delay time (inductive load)	I <sub>C</sub> = I <sub>Nenn</sub> , V <sub>CC</sub> = 600 V	t <sub>d,off</sub>	-	420	-	ns
	V <sub>GE</sub> = ±15V, T <sub>vj</sub> = 25°C, R <sub>G</sub> = 18 Ohm					
	V <sub>GE</sub> = ±15V, T <sub>vj</sub> = 125°C, R <sub>G</sub> = 18 Ohm					
Fallzeit (induktive Last) fall time (inductive load)	I <sub>C</sub> = I <sub>Nenn</sub> , V <sub>CC</sub> = 600 V	t <sub>f</sub>	-	65	-	ns
	V <sub>GE</sub> = ±15V, T <sub>vj</sub> = 25°C, R <sub>G</sub> = 18 Ohm					
	V <sub>GE</sub> = ±15V, T <sub>vj</sub> = 125°C, R <sub>G</sub> = 18 Ohm					
Einschaltverlustenergie pro Puls turn-on energy loss per pulse	I <sub>C</sub> = I <sub>Nenn</sub> , V <sub>CC</sub> = 600 V V <sub>GE</sub> = ±15V, T <sub>vj</sub> = 125°C, R <sub>G</sub> = 18 Ohm L <sub>S</sub> = 45 nH	E <sub>on</sub>	-	6,6	-	mWs
Abschaltverlustenergie pro Puls turn-off energy loss per pulse	I <sub>C</sub> = I <sub>Nenn</sub> , V <sub>CC</sub> = 600 V V <sub>GE</sub> = ±15V, T <sub>vj</sub> = 125°C, R <sub>G</sub> = 18 Ohm L <sub>S</sub> = 45 nH	E <sub>off</sub>	-	5,8	-	mWs
Kurzschlußverhalten SC Data	t <sub>P</sub> ≤ 10µs, V <sub>GE</sub> ≤ 15V, R <sub>G</sub> = 18 Ohm T <sub>vj</sub> ≤ 125°C, V <sub>CC</sub> = 720 V	I <sub>SC</sub>	-	200	-	A

# Technische Information / Technical Information

IGBT-Module  
IGBT-Modules

## FP50R12KE3

eupec

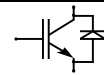

### Vorläufige Daten Preliminary data

### Elektrische Eigenschaften / Electrical properties

#### Charakteristische Werte / Characteristic values

		min.	typ.	max.		
Modulinduktivität stray inductance module		$L_{GCE}$	-	-	100	nH
Modul Leitungswiderstand, Anschlüsse-Chip lead resistance, terminals-chip	$T_C = 25^\circ C$	$R_{CC+EE}$	-	7	-	m $\Omega$
<b>Diode Wechselrichter/ Diode Inverter</b>			<b>min.</b>	<b>typ.</b>	<b>max.</b>	
Durchlaßspannung forward voltage	$V_{GE} = 0V, T_{vj} = 25^\circ C, I_F = 50 A$ $V_{GE} = 0V, T_{vj} = 125^\circ C, I_F = 50 A$	$V_F$	-	1,65	2,2	V
Rückstromspitze peak reverse recovery current	$I_F = I_{Nenn}, -di_F/dt = 1200 A/\mu s$ $V_{GE} = -10V, T_{vj} = 25^\circ C, V_R = 600 V$ $V_{GE} = -10V, T_{vj} = 125^\circ C, V_R = 600 V$	$I_{RM}$	-	51	-	A
Sperrverzögerungsladung recovered charge	$I_F = I_{Nenn}, -di_F/dt = 1200 A/\mu s$ $V_{GE} = -10V, T_{vj} = 25^\circ C, V_R = 600 V$ $V_{GE} = -10V, T_{vj} = 125^\circ C, V_R = 600 V$	$Q_r$	-	6,2	-	$\mu As$
Abschaltenergie pro Puls reverse recovery energy	$I_F = I_{Nenn}, -di_F/dt = 1200 A/\mu s$ $V_{GE} = -10V, T_{vj} = 25^\circ C, V_R = 600 V$ $V_{GE} = -10V, T_{vj} = 125^\circ C, V_R = 600 V$	$E_{RQ}$	-	2,1	-	mWs
<b>Transistor Brems-Chopper/ Transistor Brake-Chopper</b>			<b>min.</b>	<b>typ.</b>	<b>max.</b>	
Kollektor-Emitter Sättigungsspannung collector-emitter saturation voltage	$V_{GE} = 15V, T_{vj} = 25^\circ C, I_C = 40 A$ $V_{GE} = 15V, T_{vj} = 125^\circ C, I_C = 40 A$	$V_{CE sat}$	-	1,8	2,3	V
Gate-Schwellenspannung gate threshold voltage	$V_{CE} = V_{GE}, T_{vj} = 25^\circ C, I_C = 1,5 mA$	$V_{GE(TO)}$	5,0	5,8	6,5	V
Eingangskapazität input capacitance	$f = 1MHz, T_{vj} = 25^\circ C$ $V_{CE} = 25 V, V_{GE} = 0 V$	$C_{ies}$	-	2,5	-	nF
Kollektor-Emitter Reststrom collector-emitter cut off current	$V_{GE} = 0V, T_{vj} = 25^\circ C, V_{CE} = 1200 V$	$I_{CES}$	-	5,0	-	mA
Gate-Emitter Reststrom gate-emitter leakage current	$V_{CE} = 0V, V_{GE} = 20V, T_{vj} = 25^\circ C$	$I_{GES}$	-	-	400	nA
Schaltverluste und -bedingungen Switching losses and conditions	siehe Wechselrichter in Dbl FP40R12KE3 see inverter in datasheet FP40R12KE3					
<b>Diode Brems-Chopper/ Diode Brake-Chopper</b>			<b>min.</b>	<b>typ.</b>	<b>max.</b>	
Durchlaßspannung forward voltage	$T_{vj} = 25^\circ C, I_F = 40 A$ $T_{vj} = 125^\circ C, I_F = 40 A$	$V_F$	-	2,35	2,8	V
Schaltverluste und -bedingungen Switching losses and conditions	siehe Wechselrichter in Dbl FP15R12KE3 see inverter in datasheet FP15R12KE3					
<b>NTC-Widerstand/ NTC-Thermistor</b>			<b>min.</b>	<b>typ.</b>	<b>max.</b>	
Nennwiderstand rated resistance	$T_C = 25^\circ C$	$R_{25}$	-	5	-	k $\Omega$
Abweichung von $R_{100}$ deviation of $R_{100}$	$T_C = 100^\circ C, R_{100} = 493 \Omega$	$\Delta R/R$	-5		5	%
Verlustleistung power dissipation	$T_C = 25^\circ C$	$P_{25}$			20	mW
B-Wert B-value	$R_2 = R_1 \exp [B(1/T_2 - 1/T_1)]$	$B_{25/50}$		3375		K

# Technische Information / Technical Information

IGBT-Module  
IGBT-Modules

## FP50R12KE3

eupec

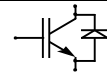

### Vorläufige Daten Preliminary data

#### Thermische Eigenschaften / Thermal properties

				min.	typ.	max.	
Innerer Wärmewiderstand thermal resistance, junction to case	Gleichr. Diode/ Rectif. Diode	$R_{thJC}$	-	-	0,65	K/W	
	Trans. Wechr./ Trans. Inverter		-	-	0,45	K/W	
	Diode Wechr./ Diode Inverter		-	-	0,75	K/W	
	Trans. Bremse/ Trans. Brake		-	-	0,6	K/W	
	Diode Bremse/ Diode Brake		-	-	1,5	K/W	
Übergangs-Wärmewiderstand thermal resistance, case to heatsink	Gleichr. Diode/ Rectif. Diode	$R_{thCK}$	-	0,04	-	K/W	
	Trans. Wechr./ Trans. Inverter		-	0,02	-	K/W	
	Diode Wechr./ Diode Inverter		-	0,04	-	K/W	
Höchstzulässige Sperrschichttemperatur maximum junction temperature		$T_{vj}$	-	-	150	°C	
Betriebstemperatur operation temperature		$T_{op}$	-40	-	125	°C	
Lagertemperatur storage temperature		$T_{stg}$	-40	-	125	°C	

#### Mechanische Eigenschaften / Mechanical properties

Innere Isolation internal insulation				$Al_2O_3$	
CTI comperative tracking index				225	
Anzugsdrehmoment f. mech. Befestigung mounting torque		M		3 ±10%	Nm
Gewicht weight		G		300	g

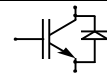

Vorläufige Daten  
Preliminary data

Ausgangskennlinienfeld Wechselr. (typisch)  $I_C = f(V_{CE})$   
Output characteristic Inverter (typical)  $V_{GE} = 15\text{ V}$

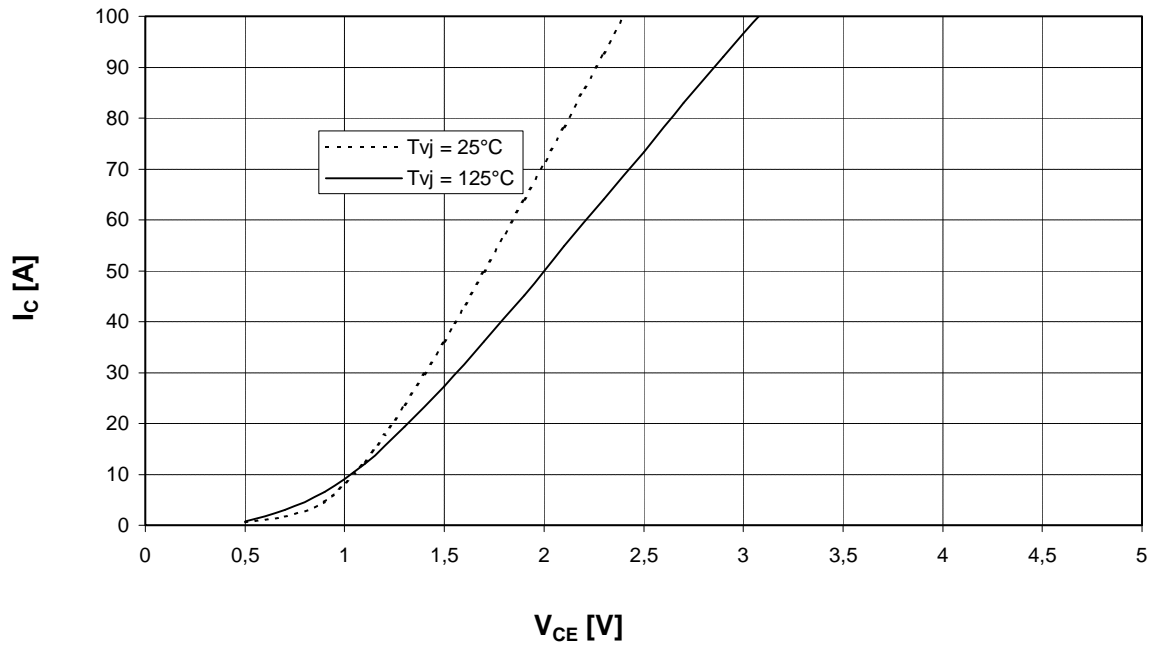

Ausgangskennlinienfeld Wechselr. (typisch)  $I_C = f(V_{CE})$   
Output characteristic Inverter (typical)  $T_{vj} = 125^\circ\text{C}$

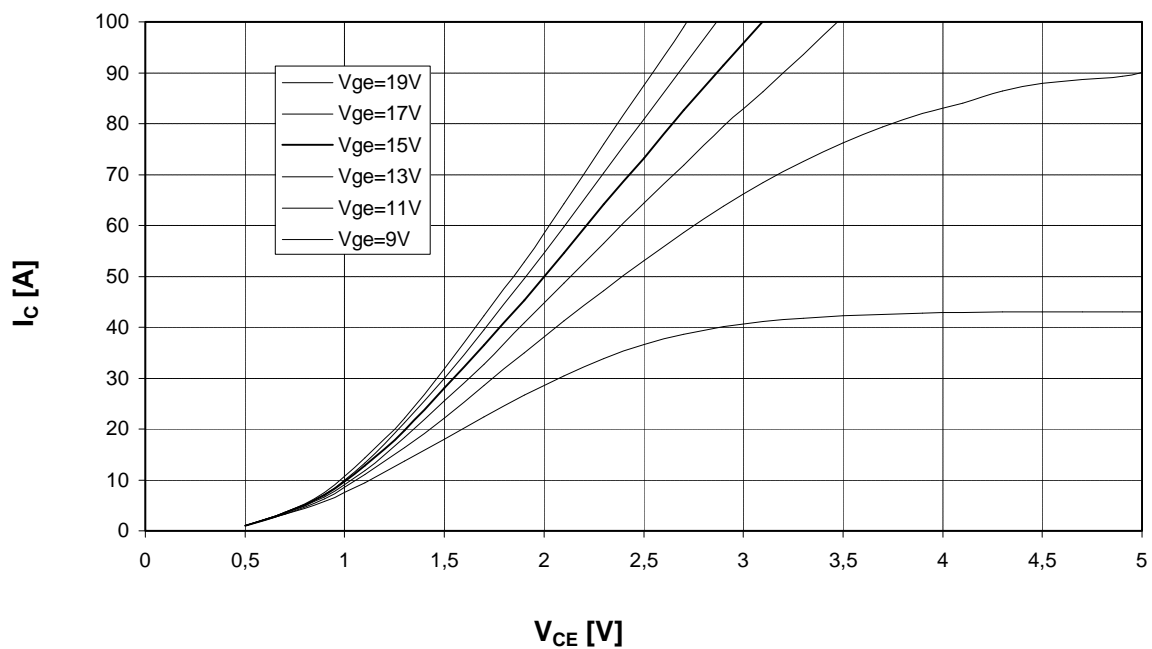

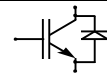

Vorläufige Daten  
Preliminary data

Übertragungscharakteristik Wechselr. (typisch)  
Transfer characteristic Inverter (typical)

$I_C = f(V_{GE})$   
 $V_{CE} = 20\text{ V}$

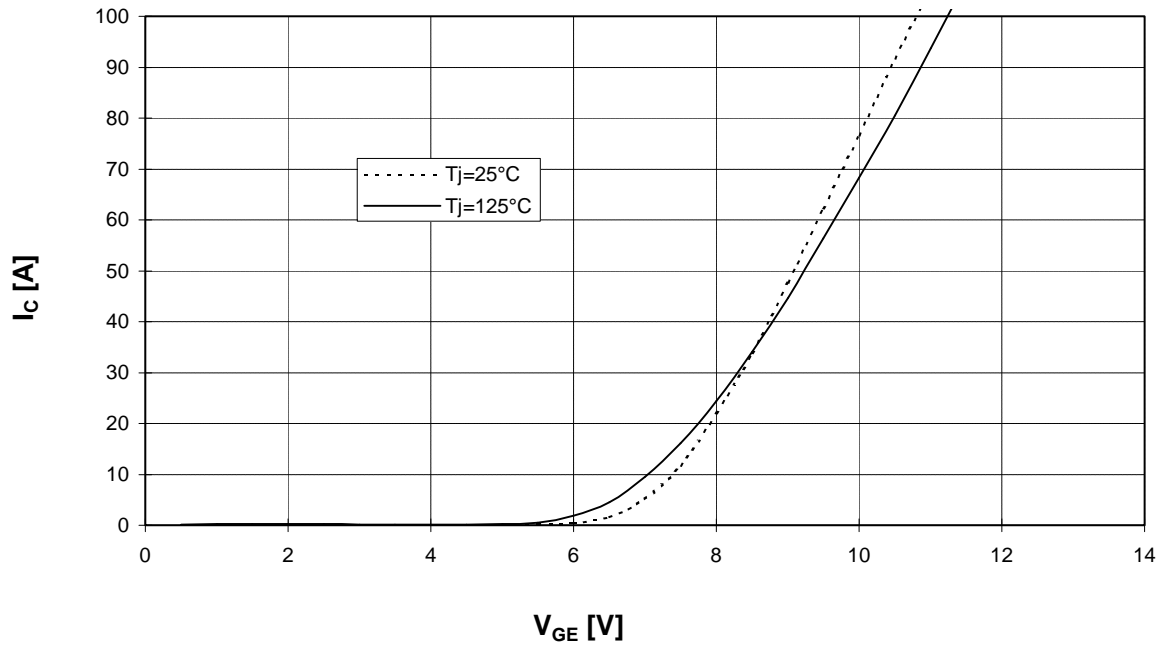

Durchlaßkennlinie der Freilaufdiode Wechselr. (typisch)  
Forward characteristic of FWD Inverter (typical)

$I_F = f(V_F)$

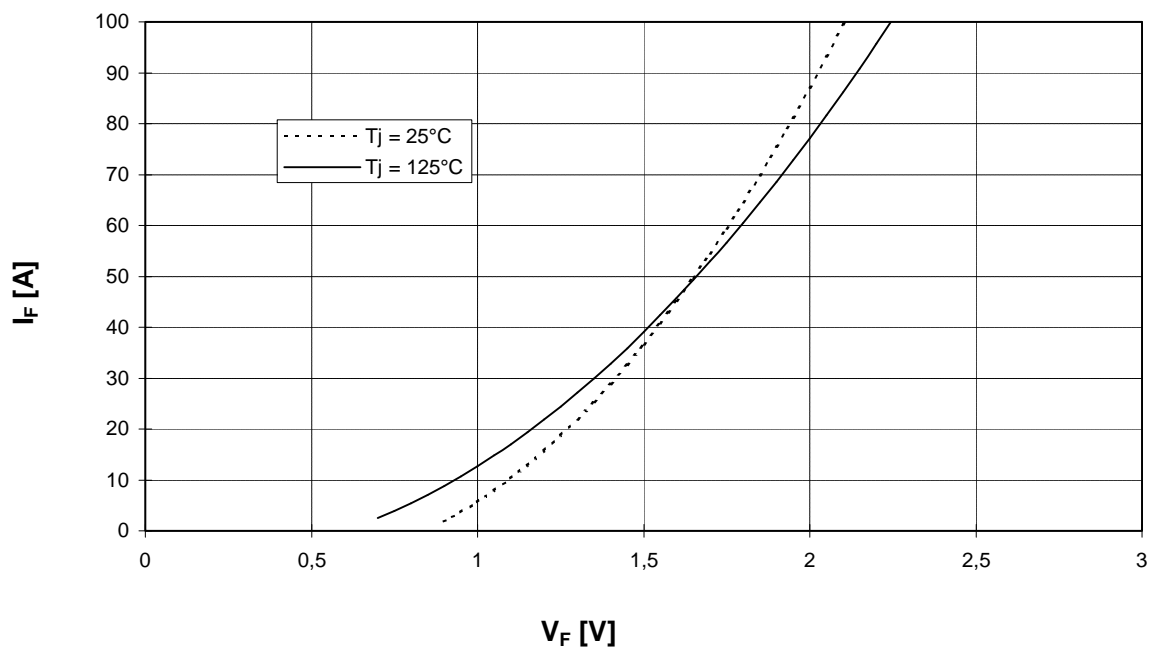

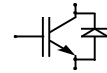

Vorläufige Daten  
Preliminary data

Schaltverluste Wechselr. (typisch)  $E_{on} = f(I_C), E_{off} = f(I_C), E_{rec} = f(I_C)$   $V_{CC} = 600\text{ V}$   
 Switching losses Inverter (typical)  $T_j = 125^\circ\text{C}, V_{GE} = \pm 15\text{ V}, R_{Gon} = R_{Goff} = 18\text{ Ohm}$

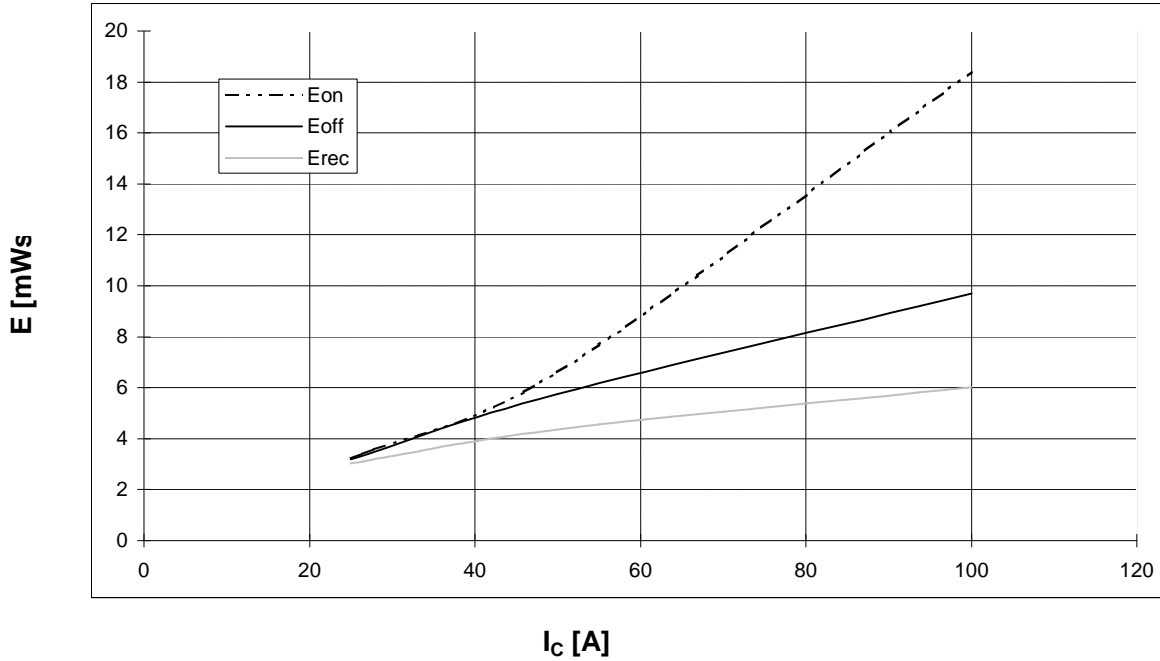

Schaltverluste Wechselr. (typisch)  $E_{on} = f(R_G), E_{off} = f(R_G), E_{rec} = f(R_G)$   
 Switching losses Inverter (typical)  $T_j = 125^\circ\text{C}, V_{GE} = \pm 15\text{ V}, I_c = I_{nenn}, V_{CC} = 600\text{ V}$

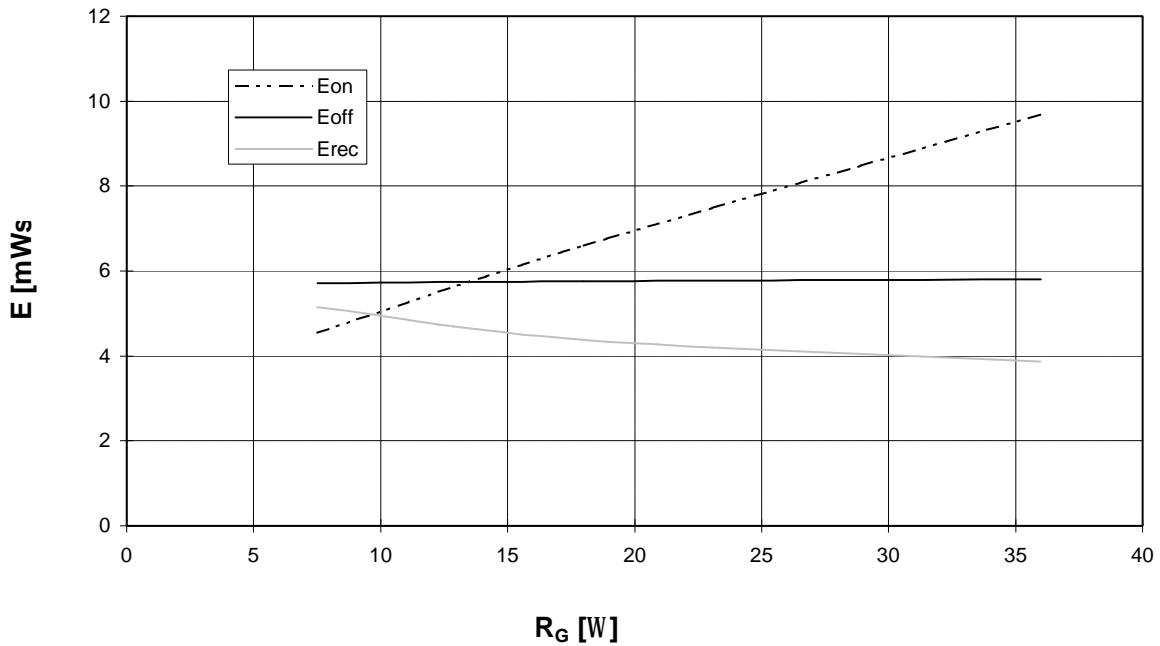

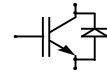

Vorläufige Daten  
Preliminary data

Transienter Wärmewiderstand Wechslr.  $Z_{thJC} = f(t)$   
Transient thermal impedance Inverter

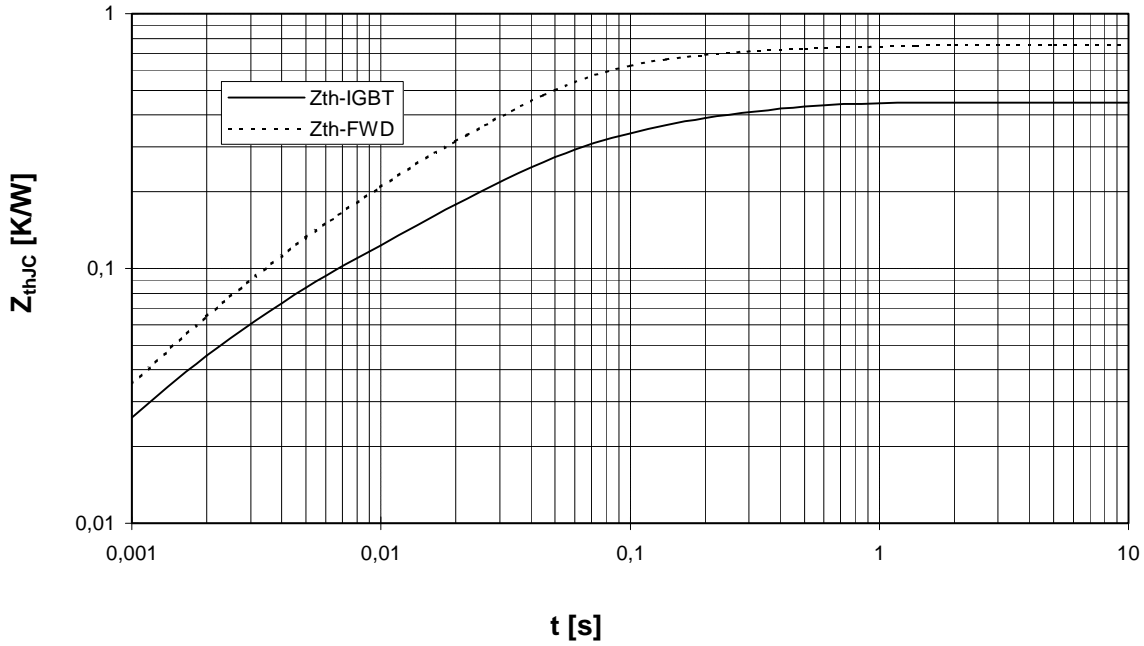

Sicherer Arbeitsbereich Wechslr. (RBSOA)  $I_C = f(V_{CE})$   
Reverse bias safe operating area Inverter (RBSOA)  $T_{vi} = 125^\circ\text{C}, V_{GE} = \pm 15\text{V}, R_G = 18 \text{ Ohm}$

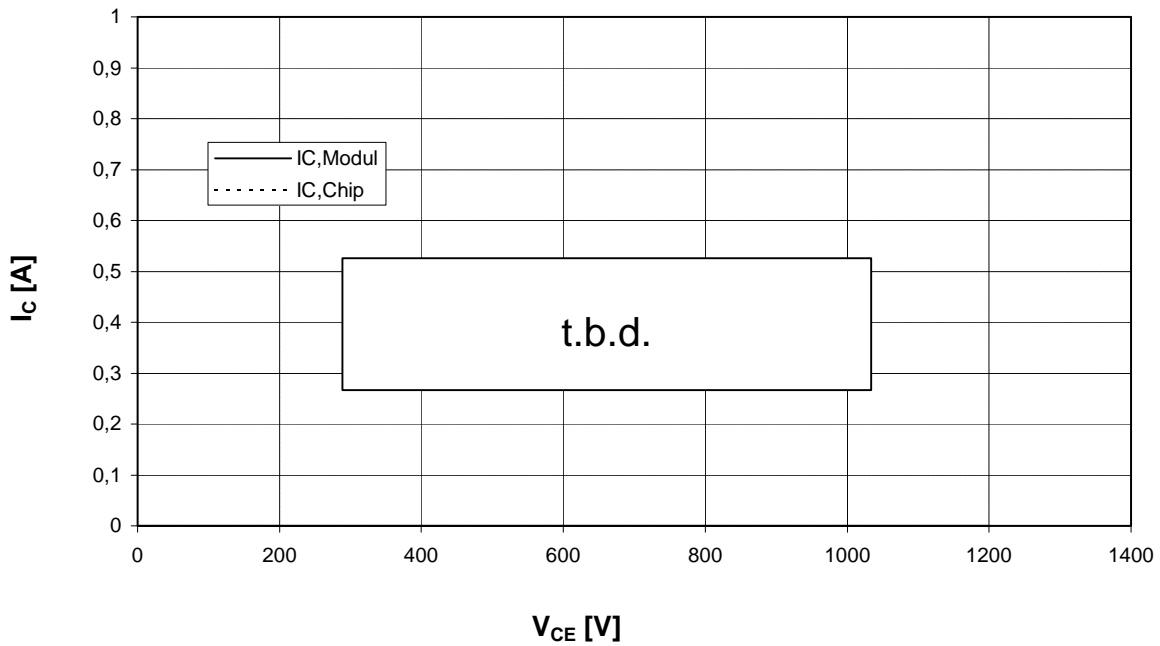



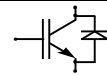

Vorläufige Daten  
Preliminary data

Ausgangskennlinienfeld Brems-Chopper-IGBT (typisch)  
Output characteristic brake-chopper-IGBT (typical)

$I_C = f(V_{CE})$   
 $V_{GE} = 15\text{ V}$

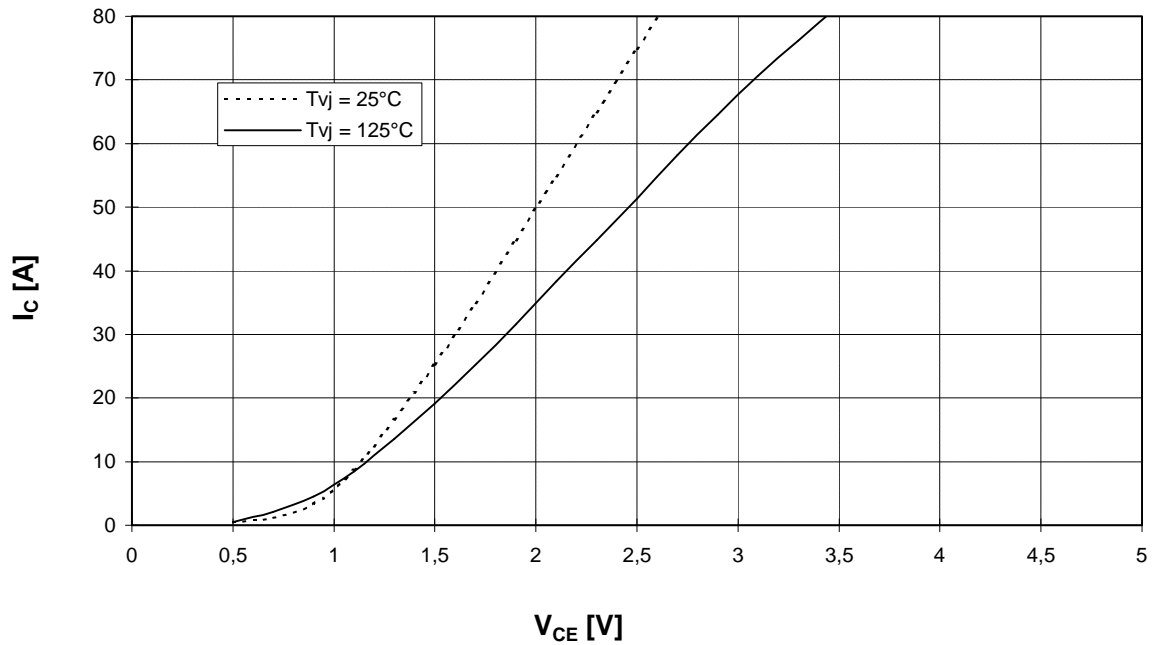

Durchlaßkennlinie der Brems-Chopper-Diode (typisch)  $I_F = f(V_F)$   
Forward characteristic of brake-chopper-FWD (typical)

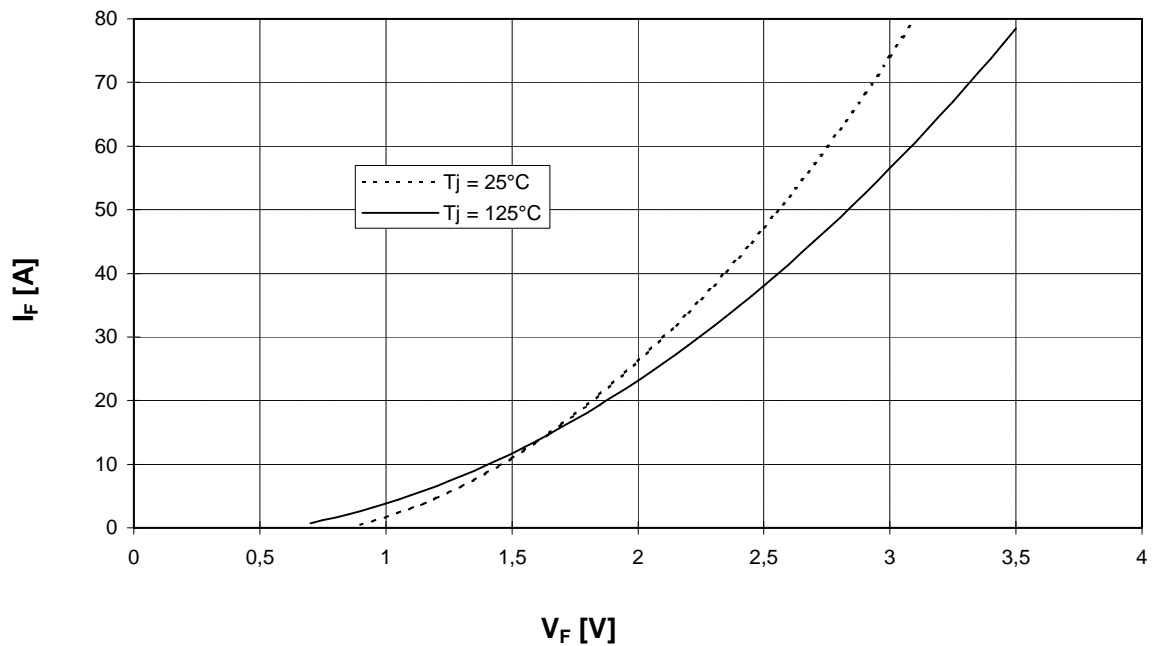

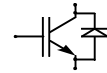

Vorläufige Daten  
Preliminary data

Durchlaßkennlinie der Gleichrichterdiode (typisch)  $I_F = f(V_F)$   
Forward characteristic of Rectifier Diode (typical)

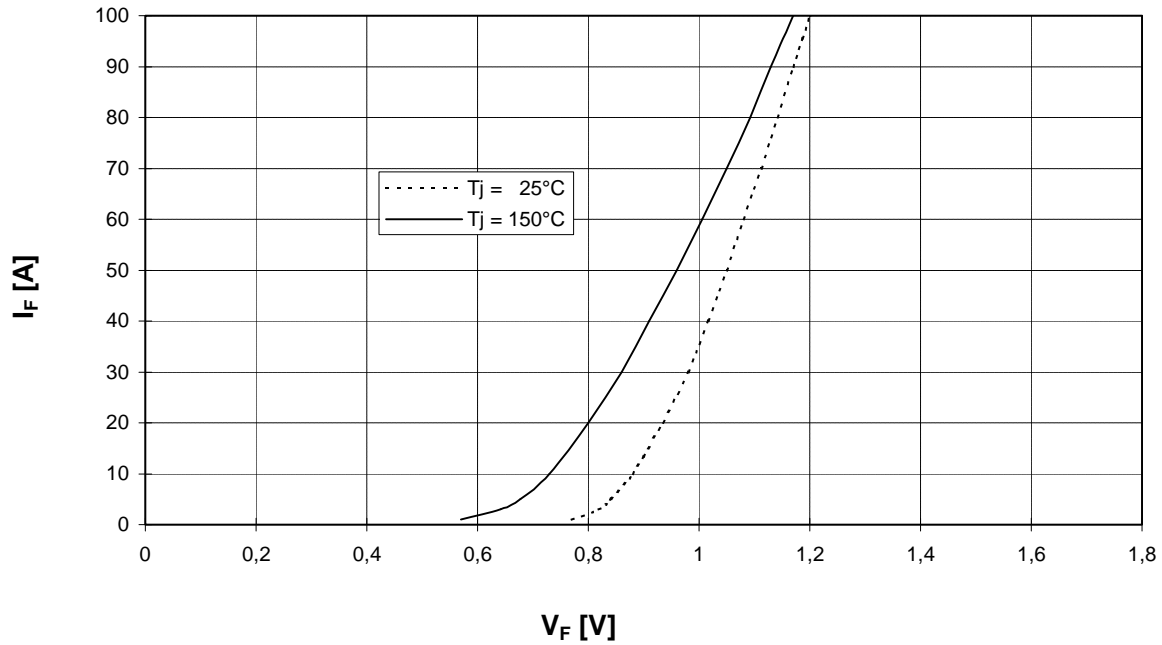

NTC- Temperaturkennlinie (typisch)  $R = f(T)$   
NTC- temperature characteristic (typical)

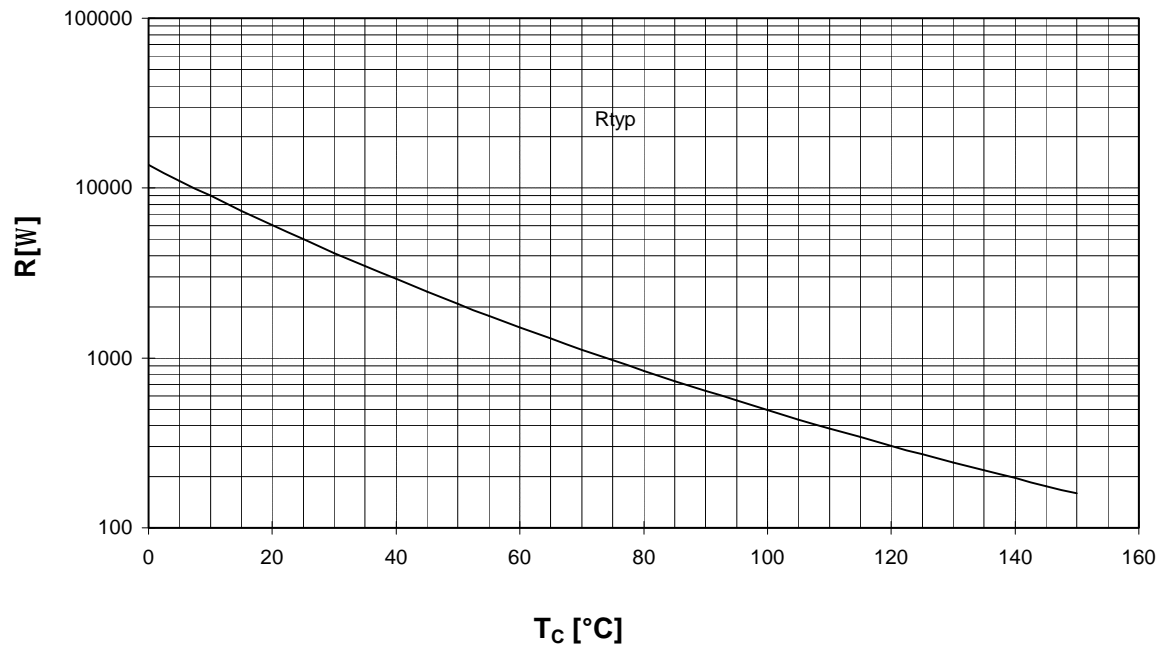

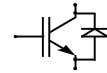

Vorläufige Daten  
Preliminary data

Schaltplan/ Circuit diagram

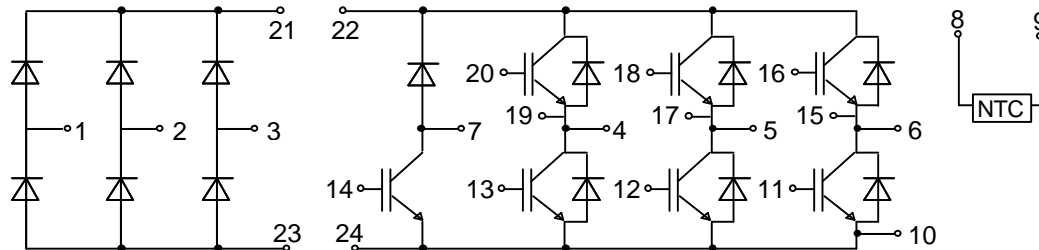

Gehäuseabmessungen/ Package outlines

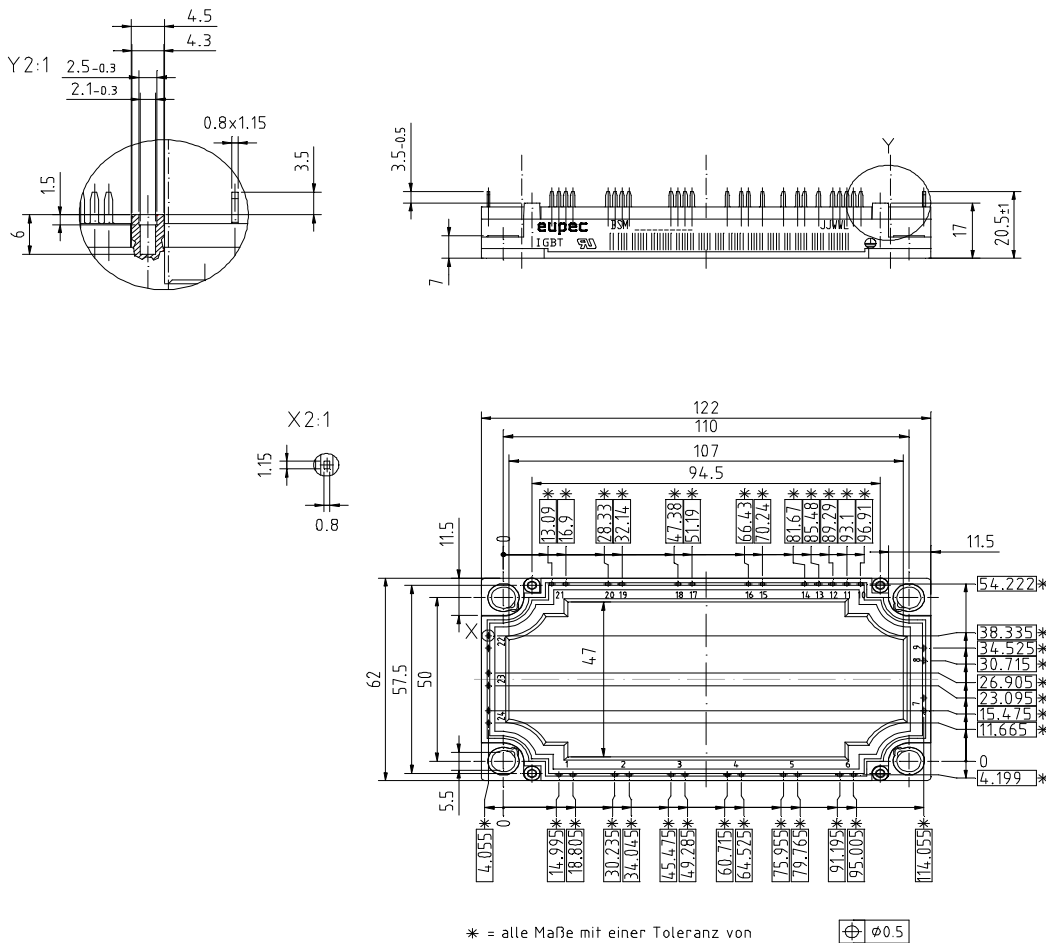

Mit dieser technischen Information werden Halbleiterbauelemente spezifiziert, jedoch keine Eigenschaften zugesichert. Sie gilt in Verbindung mit den zugehörigen Technischen Erläuterungen.

This technical information specifies semiconductor devices but promises no characteristics. It is valid in combination with the belonging technical notes.