

256Mb J-die SDRAM Specification

54 TSOP-II
with Lead-Free & Halogen-Free
(RoHS compliant)

INFORMATION IN THIS DOCUMENT IS PROVIDED IN RELATION TO SAMSUNG PRODUCTS, AND IS SUBJECT TO CHANGE WITHOUT NOTICE. NOTHING IN THIS DOCUMENT SHALL BE CONSTRUED AS GRANTING ANY LICENSE, EXPRESS OR IMPLIED, BY ESTOPPEL OR OTHERWISE, TO ANY INTELLECTUAL PROPERTY RIGHTS IN SAMSUNG PRODUCTS OR TECHNOLOGY. ALL INFORMATION IN THIS DOCUMENT IS PROVIDED ON AS "AS IS" BASIS WITHOUT GUARANTEE OR WARRANTY OF ANY KIND.

1. For updates or additional information about Samsung products, contact your nearest Samsung office.
2. Samsung products are not intended for use in life support, critical care, medical, safety equipment, or similar applications where Product failure could result in loss of life or personal or physical harm, or any military or defense application, or any governmental procurement to which special terms or provisions may apply.

* Samsung Electronics reserves the right to change products or specification without notice.

Table of Contents

1.0 Features	4
2.0 General Description	4
3.0 Ordering Information	4
4.0 Package Physical Dimension	5
5.0 Functional Block Diagram.....	6
6.0 Pin Configuration (Top view)	7
7.0 Pin Function Description	7
8.0 Absolute Maximum Ratings.....	8
9.0 DC Operating Conditions.....	8
10.0 Capacitance.....	8
11.0 DC Characteristics (x4, x8)	9
12.0 DC Characteristics (x16)	10
13.0 AC Operating Test Conditions	11
14.0 Operating AC Parameter	11
15.0 AC Characteristics	12
16.0 DQ Buffer Output Drive Characteristics	12
17.0 IBIS Specification	13
18.0 Simplified Truth Table	15

Revision History

Revision	Month	Year	History
1.0	June	2007	- Release 1.0 version SPEC
1.1	October	2007	- Changed IDD current SPEC - Revised typo of package dimension - Added the comment of Halogen-free supporting
1.2	January	2008	- Added 200Mhz speed
1.21	March	2008	- Added Package pin out lead width - Added 200MHz current SPEC
1.22	August	2008	- Corrected font format

16M x 4Bit x 4 Banks / 8M x 8Bit x 4 Banks / 4M x 16Bit x 4 Banks SDRAM

1.0 Features

- JEDEC standard 3.3V power supply
- LVTTTL compatible with multiplexed address
- Four banks operation
- MRS cycle with address key programs
 - CAS latency (2 & 3)
 - Burst length (1, 2, 4, 8 & Full page)
 - Burst type (Sequential & Interleave)
- All inputs are sampled at the positive going edge of the system clock.
- Burst read single-bit write operation
- DQM (x4,x8) & L(U)DQM (x16) for masking
- Auto & self refresh
- 64ms refresh period (8K Cycle)
- Lead-Free & Halogen-Free Package
- RoHS compliant

2.0 General Description

The K4S560432J / K4S560832J / K4S561632J is 268,435,456 bits synchronous high data rate Dynamic RAM organized as 4 x 16,777,216 words by 4 bits / 4 x 8,388,608 words by 8bits / 4 x 4,194,304 words by 16bits, fabricated with SAMSUNG's high performance CMOS technology. Synchronous design allows precise cycle control with the use of system clock I/O transactions are possible on every clock cycle. Range of operating frequencies, programmable burst length and programmable latencies allow the same device to be useful for a variety of high bandwidth, high performance memory system applications.

3.0 Ordering Information

Part No.	Organization	Max Freq.	Interface	Package
K4S560432J-U ^{*1} C/L75	64M x 4	133MHz (CL=3)	LVTTTL	54pin TSOP(II) Lead-Free & Halogen-Free ^{*1}
K4S560832J-UC/L75	32M x 8	133MHz (CL=3)		
K4S561632J-UC/L50	16M x 16	200MHz (CL=3)		
K4S561632J-UC/L60		166MHz (CL=3)		
K4S561632J-UC/L75		133MHz (CL=3)		

Note 1 : 256Mb J-die SDR DRAMs support Lead-Free & Halogen-Free package with Lead-Free package code(-U).

Organization	Row Address	Column Address
64Mx4	A0~A12	A0-A9, A11
32Mx8	A0~A12	A0-A9
16Mx16	A0~A12	A0-A8

Row & Column address configuration

4.0 Package Physical Dimension

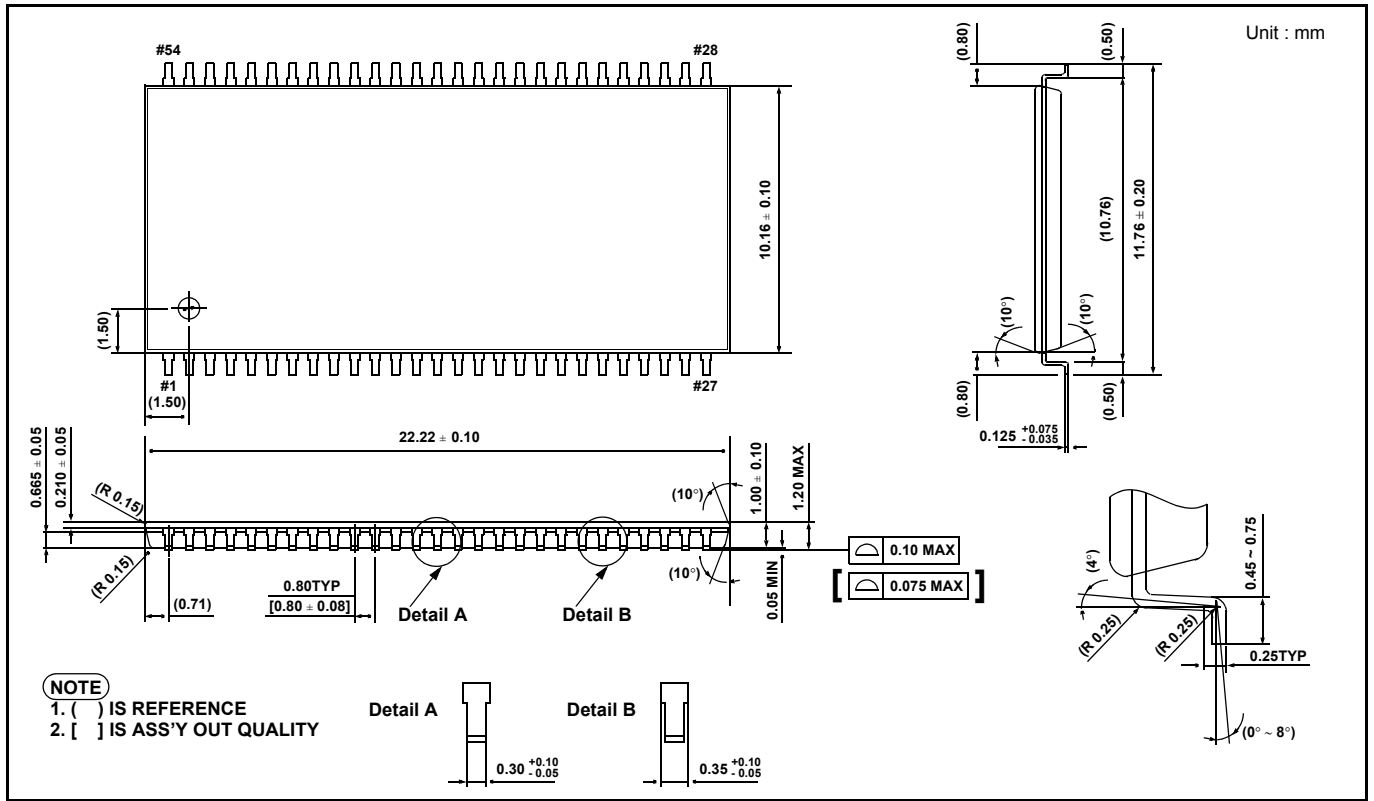

54Pin TSOP(II) Package Dimension

5.0 Functional Block Diagram

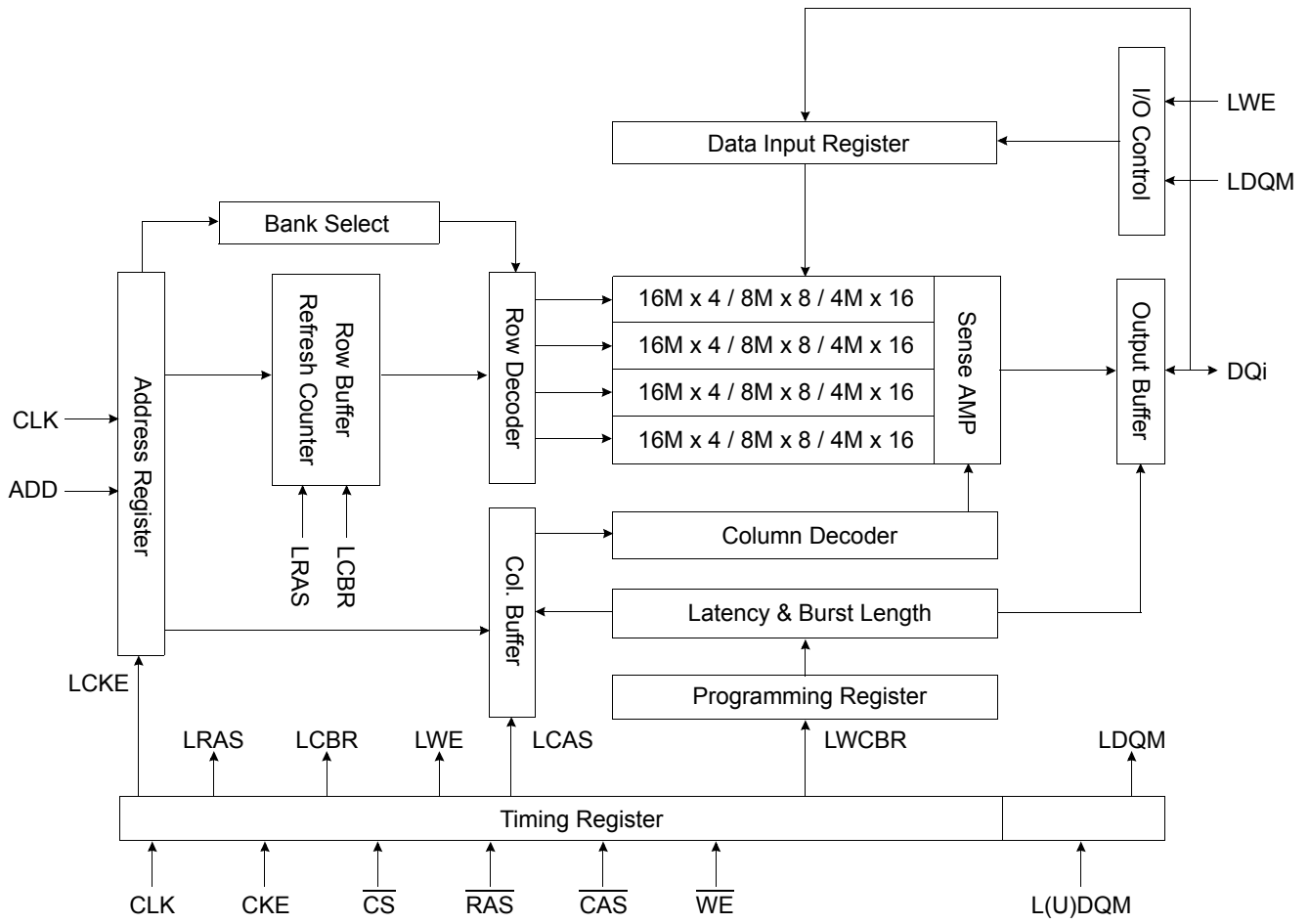

* Samsung Electronics reserves the right to change products or specification without notice.

6.0 Pin Configuration (Top view)

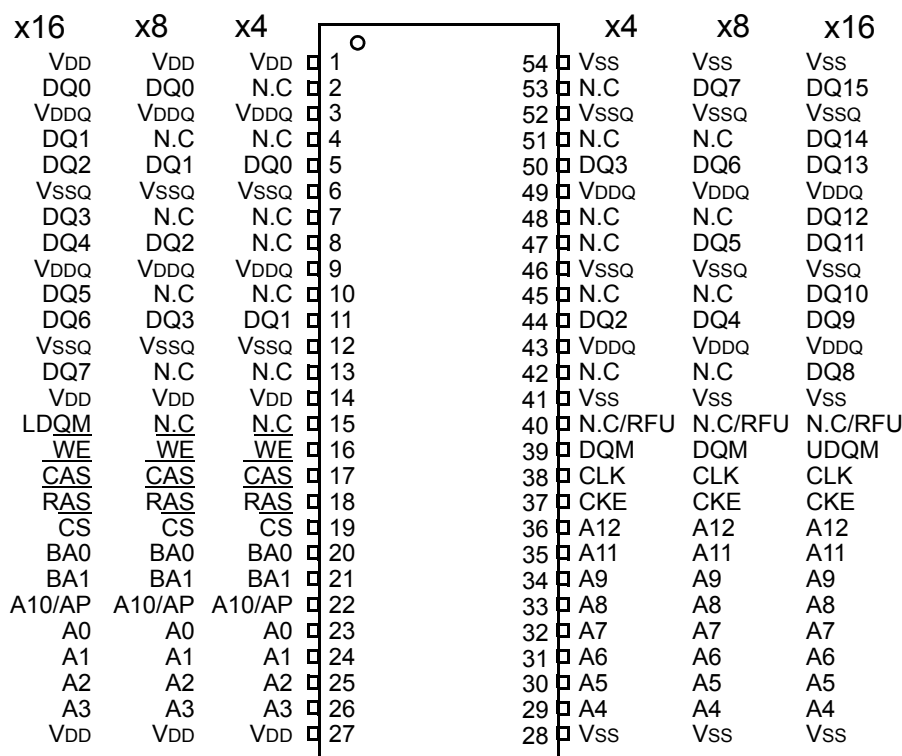

54Pin TSOP
(400mil x 875mil)
(0.8 mm Pin pitch)

7.0 Pin Function Description

Pin	Name	Input Function
CLK	System clock	Active on the positive going edge to sample all inputs.
\overline{CS}	Chip select	Disables or enables device operation by masking or enabling all inputs except CLK, CKE and DQM
CKE	Clock enable	Masks system clock to freeze operation from the next clock cycle. CKE should be enabled at least one cycle prior to new command. Disable input buffers for power down in standby.
A0 ~ A12	Address	Row/column addresses are multiplexed on the same pins. Row address : RA0 ~ RA12, Column address : (x4 : CA0 ~ CA9,CA11), (x8 : CA0 ~ CA9), (x16 : CA0 ~ CA8)
BA0 ~ BA1	Bank select address	Selects bank to be activated during row address latch time. Selects bank for read/write during column address latch time.
\overline{RAS}	Row address strobe	Latches row addresses on the positive going edge of the CLK with \overline{RAS} low. Enables row access & precharge.
\overline{CAS}	Column address strobe	Latches column addresses on the positive going edge of the CLK with \overline{CAS} low. Enables column access.
\overline{WE}	Write enable	Enables write operation and row precharge. Latches data in starting from \overline{CAS} , \overline{WE} active.
DQM	Data input/output mask	Makes data output Hi-Z, tSHZ after the clock and masks the output. Blocks data input when DQM active.
DQ0 ~ N	Data input/output	Data inputs/outputs are multiplexed on the same pins. (x4 : DQ0 ~ 3), (x8 : DQ0 ~ 7), (x16 : DQ0 ~ 15)
V _{DD} /V _{SS}	Power supply/ground	Power and ground for the input buffers and the core logic.
V _{DDQ} /V _{SSQ}	Data output power/ground	Isolated power supply and ground for the output buffers to provide improved noise immunity.
N.C/RFU	No connection /reserved for future use	This pin is recommended to be left No Connection on the device.

8.0 Absolute Maximum Ratings

Parameter	Symbol	Value	Unit
Voltage on any pin relative to V_{SS}	V_{IN}, V_{OUT}	-1.0 ~ 4.6	V
Voltage on V_{DD} supply relative to V_{SS}	V_{DD}, V_{DDQ}	-1.0 ~ 4.6	V
Storage temperature	T_{STG}	-55 ~ +150	°C
Power dissipation	P_D	1	W
Short circuit current	I_{OS}	50	mA

Note : Permanent device damage may occur if "ABSOLUTE MAXIMUM RATINGS" are exceeded.
 Functional operation should be restricted to recommended operating condition.
 Exposure to higher than recommended voltage for extended periods of time could affect device reliability.

9.0 DC Operating Conditions

Recommended operating conditions (Voltage referenced to $V_{SS} = 0V$, $T_A = 0$ to $70^\circ C$)

Parameter	Symbol	Min	Typ	Max	Unit	Note
Supply voltage	V_{DD}, V_{DDQ}	3.0	3.3	3.6	V	
Input logic high voltage	V_{IH}	2.0	3.0	$V_{DD}+0.3$	V	1
Input logic low voltage	V_{IL}	-0.3	0	0.8	V	2
Output logic high voltage	V_{OH}	2.4	-	-	V	$I_{OH} = -2mA$
Output logic low voltage	V_{OL}	-	-	0.4	V	$I_{OL} = 2mA$
Input leakage current	I_{LI}	-10	-	10	uA	3

Notes : 1. V_{IH} (max) = 5.6V AC. The overshoot voltage duration is $\leq 3ns$.
 2. V_{IL} (min) = -2.0V AC. The undershoot voltage duration is $\leq 3ns$.
 3. Any input $0V \leq V_{IN} \leq V_{DDQ}$.
 Input leakage currents include Hi-Z output leakage for all bi-directional buffers with Tri-State outputs.

10.0 Capacitance

($V_{DD} = 3.3V$, $T_A = 23^\circ C$, $f = 1MHz$, $V_{REF} = 1.4V \pm 200 mV$)

Pin	Symbol	Min	Max	Unit
Clock	CCLK	2.5	3.5	pF
RAS, CAS, WE, CS, CE, DQM	CIN	2.5	3.8	pF
Address	CADD	2.5	3.8	pF
(x4 : DQ0 ~ DQ3), (x8 : DQ0 ~ DQ7), (x16 : DQ0 ~ DQ15)	COUT	4.0	6.0	pF

11.0 DC Characteristics (x4, x8) (Recommended operating condition unless otherwise noted, TA = 0 to 70°C)

Parameter	Symbol	Test Condition	Version	Unit	Note	
			75			
Operating current (One bank active)	I _{CC1}	Burst length = 1 t _{RC} ≥ t _{RC} (min) IO = 0 mA	70	mA	1	
Precharge standby current in power-down mode	I _{CC2P}	CKE ≤ V _{IL} (max), t _{CC} = 10ns	2	mA		
	I _{CC2PS}	CKE & CLK ≤ V _{IL} (max), t _{CC} = ∞	2			
Precharge standby current in non power-down mode	I _{CC2N}	CKE ≥ V _{IH} (min), $\overline{CS} \geq V_{IH}(\min)$, t _{CC} = 10ns Input signals are changed one time during 20ns	15	mA		
	I _{CC2NS}	CKE ≥ V _{IH} (min), CLK ≤ V _{IL} (max), t _{CC} = ∞ Input signals are stable	10			
Active standby current in power-down mode	I _{CC3P}	CKE ≤ V _{IL} (max), t _{CC} = 10ns	5	mA		
	I _{CC3PS}	CKE & CLK ≤ V _{IL} (max), t _{CC} = ∞	5			
Active standby current in non power-down mode (One bank active)	I _{CC3N}	CKE ≥ V _{IH} (min), $\overline{CS} \geq V_{IH}(\min)$, t _{CC} = 10ns Input signals are changed one time during 20ns	28	mA		
	I _{CC3NS}	CKE ≥ V _{IH} (min), CLK ≤ V _{IL} (max), t _{CC} = ∞ Input signals are stable	20			
Operating current (Burst mode)	I _{CC4}	IO = 0 mA Page burst 4banks Activated. t _{CCD} = 2CLKs	110	mA	1	
Refresh current	I _{CC5}	t _{RC} ≥ t _{RC} (min)	160	mA	2	
Self refresh current	I _{CC6}	CKE ≤ 0.2V	C	3	mA	3
			L	1.5	mA	4

- Notes :**
1. Measured with outputs open.
 2. Refresh period is 64ms.
 3. K4S5604(08)32J-UC
 4. K4S5604(08)32J-UL
 5. Unless otherwise noticed, input swing level is CMOS(V_{IH}/V_{IL}=V_{DDQ}/V_{SSQ}).

12.0 DC Characteristics (x16)

(Recommended operating condition unless otherwise noted, TA = 0 to 70°C)

Parameter	Symbol	Test Condition	Version			Unit	Note
			50	60	75		
Operating current (One bank active)	I _{CC1}	Burst length = 1 t _{RC} ≥ t _{RC(min)} IO = 0 mA	110	90	70	mA	1
Precharge standby current in power-down mode	I _{CC2P}	CKE ≤ V _{IL(max)} , t _{CC} = 10ns	2			mA	
	I _{CC2PS}	CKE & CLK ≤ V _{IL(max)} , t _{CC} = ∞	2				
Precharge standby current in non power-down mode	I _{CC2N}	CKE ≥ V _{IH(min)} , $\overline{\text{CS}} \geq V_{IH(min)}$, t _{CC} = 10ns Input signals are changed one time during 20ns	15			mA	
	I _{CC2NS}	CKE ≥ V _{IH(min)} , CLK ≤ V _{IL(max)} , t _{CC} = ∞ Input signals are stable	10				
Active standby current in power-down mode	I _{CC3P}	CKE ≤ V _{IL(max)} , t _{CC} = 10ns	5			mA	
	I _{CC3PS}	CKE & CLK ≤ V _{IL(max)} , t _{CC} = ∞	5				
Active standby current in non power-down mode (One bank active)	I _{CC3N}	CKE ≥ V _{IH(min)} , $\overline{\text{CS}} \geq V_{IH(min)}$, t _{CC} = 10ns Input signals are changed one time during 20ns	28			mA	
	I _{CC3NS}	CKE ≥ V _{IH(min)} , CLK ≤ V _{IL(max)} , t _{CC} = ∞ Input signals are stable	20				
Operating current (Burst mode)	I _{CC4}	IO = 0 mA Page burst 4banks Activated. t _{CCD} = 2CLKs	140	120	110	mA	1
Refresh current	I _{CC5}	t _{RC} ≥ t _{RC(min)}	200	180	160	mA	2
Self refresh current	I _{CC6}	CKE ≤ 0.2V	C	3		mA	3
			L	1.5			

Notes : 1. Measured with outputs open.

2. Refresh period is 64ms.

3. K4S561632J-UC

4. K4S561632J-UL

5. Unless otherwise noticed, input swing level is CMOS(V_{IH}/V_{IL}=V_{DDQ}/V_{SSQ}).

13.0 AC Operating Test Conditions

($V_{DD} = 3.3V \pm 0.3V$, $T_A = 0$ to $70^\circ C$)

Parameter	Value	Unit
AC input levels (V_{IH}/V_{IL})	2.4/0.4	V
Input timing measurement reference level	1.4	V
Input rise and fall time	tr/tf = 1/1	ns
Output timing measurement reference level	1.4	V
Output load condition	See Fig. 2	

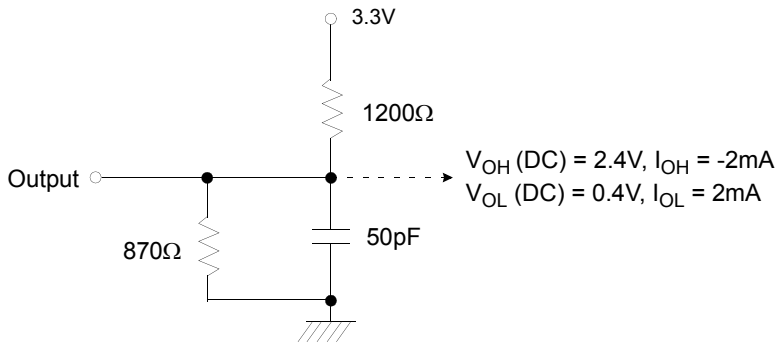

(Fig. 1) DC output load circuit

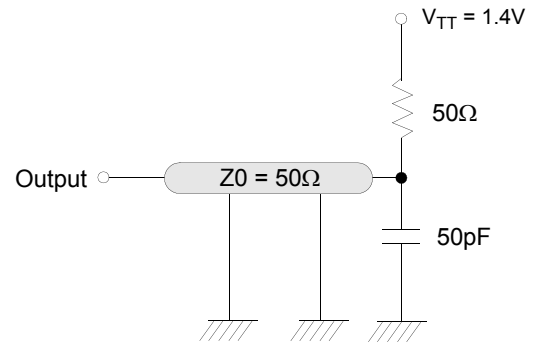

(Fig. 2) AC output load circuit

14.0 Operating AC Parameter

(AC operating conditions unless otherwise noted)

Parameter	Symbol	Version			Unit	Note
		50 (x16 only)	60 (x16 only)	75		
Row active to row active delay	tRRD(min)	10	12	15	ns	1
RAS to CAS delay	tRCD(min)	15	18	20	ns	1
Row precharge time	tRP(min)	15	18	20	ns	1
Row active time	tRAS(min)	37.5	42	45	ns	1
	tRAS(max)	100			us	
Row cycle time	tRC(min)	55	60	65	ns	1
Last data in to row precharge	tRDL(min)	2			CLK	2,5
Last data in to Active delay	tDAL(min)	2 CLK + tRP			-	5
Last data in to new col. address delay	tCDL(min)	1			CLK	2
Last data in to burst stop	tBDL(min)	1			CLK	2
Col. address to col. address delay	tCCD(min)	1			CLK	3
Number of valid output data	CAS latency=3	2			ea	4
	CAS latency=2	-		1		

- Notes :**
- The minimum number of clock cycles is determined by dividing the minimum time required with clock cycle time and then rounding off to the next higher integer.
 - Minimum delay is required to complete write.
 - All parts allow every cycle column address change.
 - In case of row precharge interrupt, auto precharge and read burst stop.
 - In 100MHz and below 100MHz operating conditions, tRDL=1CLK and tDAL=1CLK + 20ns is also supported. SAMSUNG recommends tRDL=2CLK and tDAL=2CLK + tRP.
 - tRC =tRFC, tRDL = tWR.

15.0 AC Characteristics

(AC operating conditions unless otherwise noted)

Parameter		Symbol	50 (x16 only)		60(x16 only)		75		Unit	Note
			Min	Max	Min	Max	Min	Max		
CLK cycle time	CAS latency=3	tCC	5	1000	6	1000	7.5	1000	ns	1
	CAS latency=2		-		-		10			
CLK to valid output delay	CAS latency=3	tSAC	-	4.5	-	5	-	5.4	ns	1,2
	CAS latency=2		-	-	-	-	6			
Output data hold time	CAS latency=3	tOH	2	-	2.5	-	3	ns	2	
	CAS latency=2		-	-	-	-	3			
CLK high pulse width		tCH	2	-	2.5	-	2.5	ns	3	
CLK low pulse width		tCL	2	-	2.5	-	2.5	ns	3	
Input setup time		tSS	1.5	-	1.5	-	1.5	ns	3	
Input hold time		tSH	1	-	1	-	0.8	ns	3	
CLK to output in Low-Z		tSLZ	1	-	1	-	1	ns	2	
CLK to output in Hi-Z	CAS latency=3	tSHZ	-	4.5	-	5	-	5.4	ns	
	CAS latency=2		-	-	-	-	6			

- Notes :**
- Parameters depend on programmed CAS latency.
 - If clock rising time is longer than 1ns, $(tr/2-0.5)ns$ should be added to the parameter.
 - Assumed input rise and fall time (tr & tf) = 1ns.
If tr & tf is longer than 1ns, transient time compensation should be considered, i.e., $[(tr + tf)/2-1]ns$ should be added to the parameter.
 - tSS applies for address setup time, clock enable setup time. command setup time and data setup time
tSH applies for address hold time, clock enable hold time. command hold time and data hold time

16.0 DQ Buffer Output Drive Characteristics

Parameter	Symbol	Condition	Min	Typ	Max	Unit	Notes
Output rise time	trh	Measure in linear region : 1.2V ~ 1.8V	1.37		4.37	Volts/ns	3
Output fall time	tfh	Measure in linear region : 1.2V ~ 1.8V	1.30		3.8	Volts/ns	3
Output rise time	trh	Measure in linear region : 1.2V ~ 1.8V	2.8	3.9	5.6	Volts/ns	1,2
Output fall time	tfh	Measure in linear region : 1.2V ~ 1.8V	2.0	2.9	5.0	Volts/ns	1,2

- Notes :**
- Rise time specification based on $0pF + 50 \Omega$ to V_{SS} , use these values to design to.
 - Fall time specification based on $0pF + 50 \Omega$ to V_{DD} , use these values to design to.
 - Measured into 50pF only, use these values to characterize to.
 - All measurements done with respect to V_{SS} .

17.0 IBIS Specification

I_{OH} Characteristics (Pull-up)

Voltage	166MHz 133MHz Min	166MHz 133MHz Max
(V)	I (mA)	I (mA)
3.45		-2.4
3.3		-27.3
3.0	0.0	-74.1
2.6	-21.1	-129.2
2.4	-34.1	-153.3
2.0	-58.7	-197.0
1.8	-67.3	-226.2
1.65	-73.0	-248.0
1.5	-77.9	-269.7
1.4	-80.8	-284.3
1.0	-88.6	-344.5
0.0	-93.0	-502.4

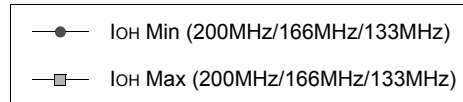
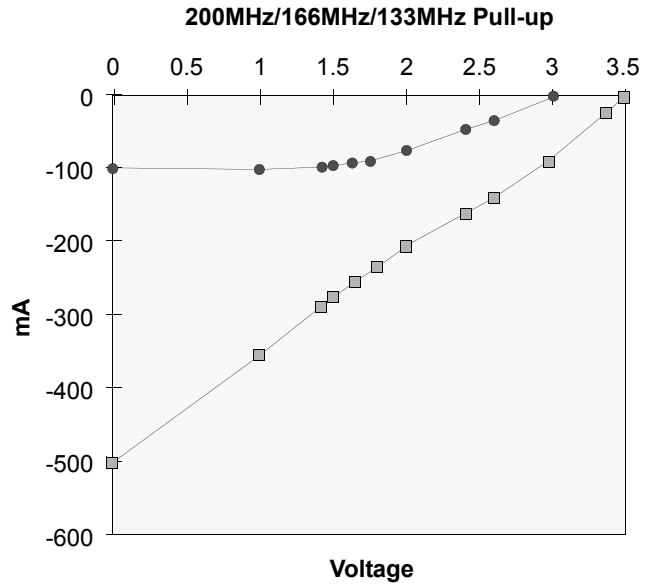

I_{OL} Characteristics (Pull-down)

Voltage	166MHz 133MHz Min	166MHz 133MHz Max
(V)	I (mA)	I (mA)
0.0	0.0	0.0
0.4	27.5	70.2
0.65	41.8	107.5
0.85	51.6	133.8
1.0	58.0	151.2
1.4	70.7	187.7
1.5	72.9	194.4
1.65	75.4	202.5
1.8	77.0	208.6
1.95	77.6	212.0
3.0	80.3	219.6
3.45	81.4	222.6

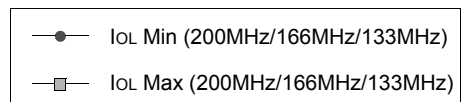
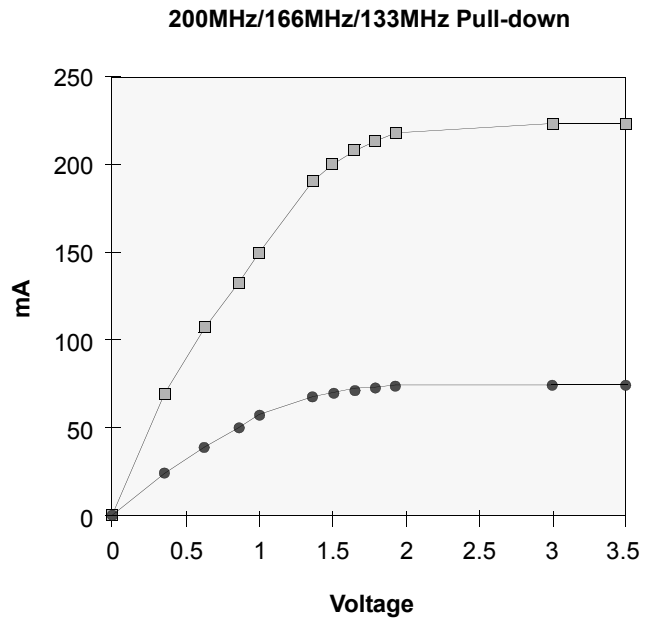

V_{DD} Clamp @ CLK, CKE, CS, DQM & DQ

V _{DD} (V)	I (mA)
0.0	0.0
0.2	0.0
0.4	0.0
0.6	0.0
0.7	0.0
0.8	0.0
0.9	0.0
1.0	0.23
1.2	1.34
1.4	3.02
1.6	5.06
1.8	7.35
2.0	9.83
2.2	12.48
2.4	15.30
2.6	18.31

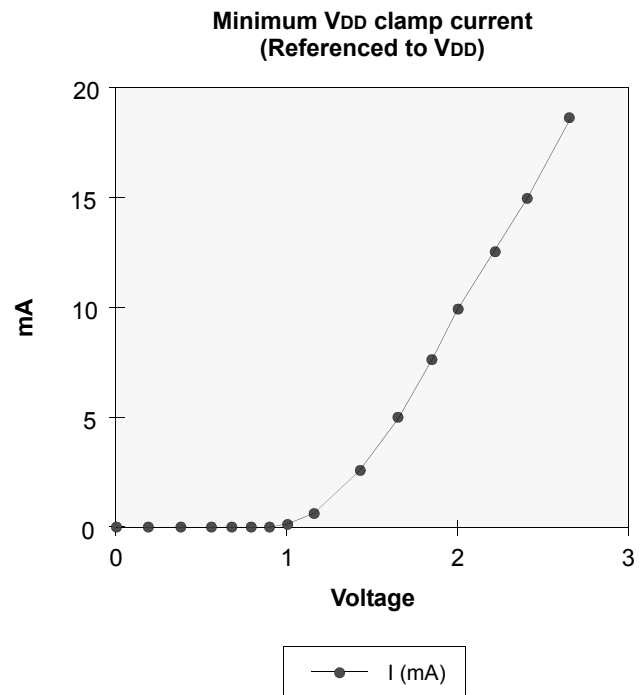

V_{SS} Clamp @ CLK, CKE, CS, DQM & DQ

V _{SS} (V)	I (mA)
-2.6	-57.23
-2.4	-45.77
-2.2	-38.26
-2.0	-31.22
-1.8	-24.58
-1.6	-18.37
-1.4	-12.56
-1.2	-7.57
-1.0	-3.37
-0.9	-1.75
-0.8	-0.58
-0.7	-0.05
-0.6	0.0
-0.4	0.0
-0.2	0.0
0.0	0.0

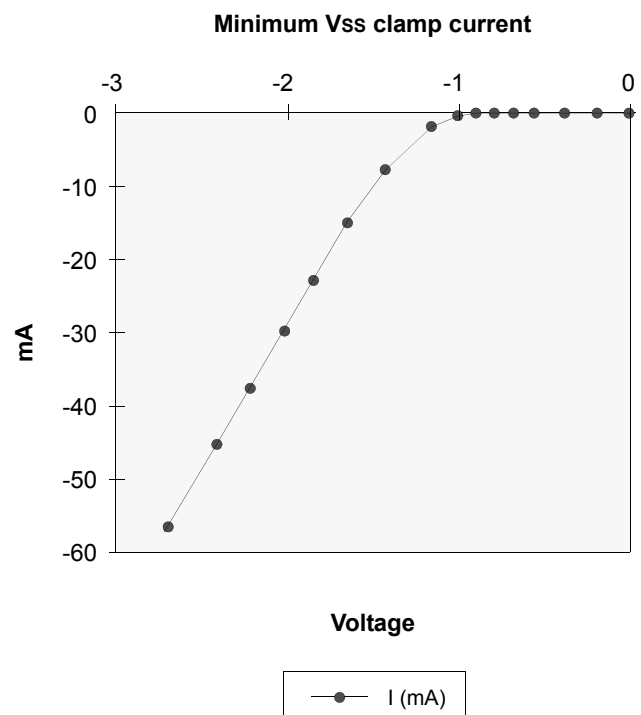

18.0 Simplified Truth Table

(V=Valid, X=Don't care, H=Logic high, L=Logic low)

Command		CKEn-1	CKEn	CS	RAS	CAS	WE	DQM	BA0,1	A10/AP	A0 ~ A9 A11, A12	Note
Register	Mode register set	H	X	L	L	L	L	X	OP code			1,2
Refresh	Auto refresh	H	H	L	L	L	H	X	X			3
	Self refresh		Entry								L	
		Exit	L	H	L	H	H	H	X	X		3
	H				X	X	X	3				
Bank active & row addr.		H	X	L	L	H	H	X	V	Row address		
Read & column address	Auto precharge disable	H	X	L	H	L	H	X	V	L	Column address	4
	Auto precharge enable									H		4,5
Write & column address	Auto precharge disable	H	X	L	H	L	L	X	V	L	Column address	4
	Auto precharge enable									H		4,5
Burst stop		H	X	L	H	H	L	X	X			6
Precharge	Bank selection	H	X	L	L	H	L	X	V	L	X	
	All banks								X	H		
Clock suspend or active power down	Entry	H	L	H	X	X	X	X	X			
				L	V	V	V					
	Exit	L	H	X	X	X	X	X	X			
Precharge power down mode	Entry	H	L	H	X	X	X	X	X			
				L	H	H	H					
	Exit	L	H	H	X	X	X	X	X			
				L	V	V	V					
DQM		H		X				V	X			7
No operation command		H	X	H	X	X	X	X	X			
				L	H	H	H					

Notes : 1. OP Code : Operand code

A0 ~ A12 & BA0 ~ BA1 : Program keys. (@ MRS)

2. MRS can be issued only at all banks precharge state.

A new command can be issued after 2 CLK cycles of MRS.

3. Auto refresh functions are as same as CBR refresh of DRAM.

The automatical precharge without row precharge command is meant by "Auto".

Auto/self refresh can be issued only at all banks precharge state.

4. BA0 ~ BA1 : Bank select addresses.

If both BA0 and BA1 are "Low" at read, write, row active and precharge, bank A is selected.

If BA0 is "High" and BA1 is "Low" at read, write, row active and precharge, bank B is selected.

If BA0 is "Low" and BA1 is "High" at read, write, row active and precharge, bank C is selected.

If both BA0 and BA1 are "High" at read, write, row active and precharge, bank D is selected.

If A10/AP is "High" at row precharge, BA0 and BA1 is ignored and all banks are selected.

5. During burst read or write with auto precharge, new read/write command can not be issued.

Another bank read/write command can be issued after the end of burst.

New row active of the associated bank can be issued at tRP after the end of burst.

6. Burst stop command is valid at every burst length.

7. DQM sampled at positive going edge of a CLK and masks the data-in at the very CLK (Write DQM latency is 0), but makes Hi-Z state the data-out of 2 CLK cycles after. (Read DQM latency is 2)