

DESCRIPTION

The SG79xxA/SG79xx series of negative regulators offer self-contained, fixed-voltage capability with up to 1.5A of load current and input voltage up to -30V. With a variety of output voltages this regulator series is an optimum complement to the SG7800A/SG7800 positive three terminal regulators.

These units feature a unique band gap reference which allows the SG79xxA series to be specified with an output voltage tolerance of $\pm 1.5\%$.

The SG79xxA versions also offer much improved line regulation characteristics.

All protective features of thermal shutdown, current limiting, and safe-area

control have been designed into these units and since these regulators require only a single output capacitor (SG79xx series) or a capacitor and 5mA minimum load (SG120 series) for satisfactory performance, ease of application is assured.

Although designed as fixed-voltage regulators, the output voltage can be increased through the use of a simple voltage divider. The low quiescent drain current of the device insures good regulation when this method is used.

These devices are available in hermetically sealed TO-257 (both case grounded 'G' and isolated 'IG'), TO-3, TO-39 and LCC packages.

IMPORTANT: For the most current data, consult MICROSEMI's website: <http://www.microsemi.com>

KEY FEATURES

- Output Voltage Set Internally to $\pm 1.5\%$ on SG79xxA
- Output Current to 1.5A
- Excellent Line and Load Regulation
- Foldback Current Limiting
- Thermal Overload Protection
- Voltages Available: -5V, -12V, -15V
- Contact Factory for Other Voltage Options
- Available in Surface Mount Package

HIGH RELIABILITY FEATURES
- SG79xxA/SG79xx

- Available to MIL-STD - 883, ¶ 1.2.1
- MIL-M38510/11501BXA - JAN7905T
- MIL-M38510/11505BYA - JAN7905K
- MIL-M38510/11502BXA - JAN7912T
- MIL-M38510/11506BYA - JAN7912K
- MIL-M38510/11503BXA - JAN7915T
- MIL-M38510/11507BYA - JAN7915K
- MIL-M38510/11508BYA - JAN7924K
- MSC-AMSG level "S" Processing Available
- Available to DSCC
- Standard Microcircuit Drawing (SMD)

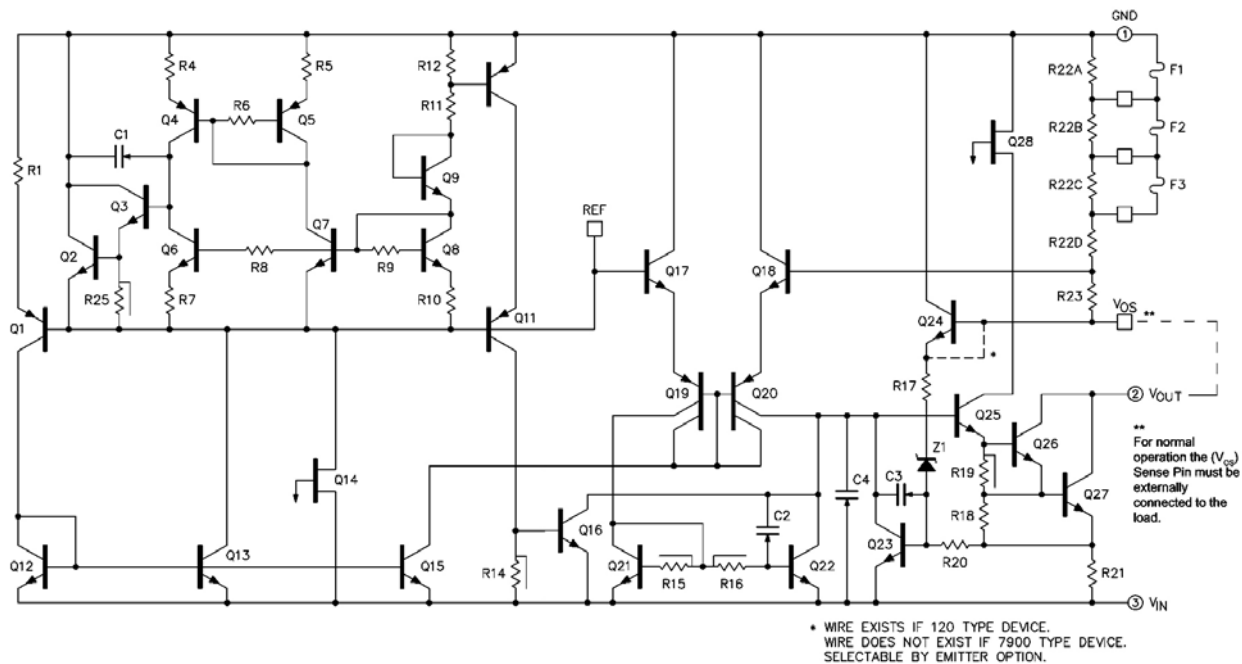
PRODUCT HIGHLIGHT
SCHEMATIC DIAGRAM

ABSOLUTE MAXIMUM RATINGS

Device Output Voltage	Input Voltage	Input Voltage Differential (Output Shorted to Ground)
-5V	-35V	35V
-12V	-35V	35V
-15V	-40V	35V

Operating Junction Temperature	150°C
Storage Temperature Range	-65°C to 150°C
Lead Temperature (Soldering 10 seconds)	300°C

Note: Exceeding these ratings could cause damage to the device. All voltages are with respect to Ground. Currents are positive into, negative out of specified terminal.

THERMAL DATA
K TO-3 3-Pin Metal Can

THERMAL RESISTANCE-JUNCTION TO CASE, θ_{JC}	3.0°C/W
THERMAL RESISTANCE-JUNCTION TO AMBIENT, θ_{JA}	35°C/W

T TO-39 3-Pin Metal Can

THERMAL RESISTANCE-JUNCTION TO CASE, θ_{JC}	15°C/W
THERMAL RESISTANCE-JUNCTION TO AMBIENT, θ_{JA}	120°C/W

G TO-257 3-Pin Hermetic

THERMAL RESISTANCE-JUNCTION TO CASE, θ_{JC}	3.5°C/W
THERMAL RESISTANCE-JUNCTION TO AMBIENT, θ_{JA}	42°C/W

IG TO-257 3-Pin Hermetic (Isolated)

THERMAL RESISTANCE-JUNCTION TO CASE, θ_{JC}	4.0°C/W
THERMAL RESISTANCE-JUNCTION TO AMBIENT, θ_{JA}	42°C/W

L Leadless Chip Carrier 20-Pin Ceramic

THERMAL RESISTANCE-JUNCTION TO CASE, θ_{JC}	35°C/W
THERMAL RESISTANCE-JUNCTION TO AMBIENT, θ_{JA}	120°C/W

Junction Temperature Calculation: $T_J = T_A + (P_D \times \theta_{JA})$.

The θ_{JA} numbers are guidelines for the thermal performance of the device/pc-board system. All of the above assume no ambient airflow.

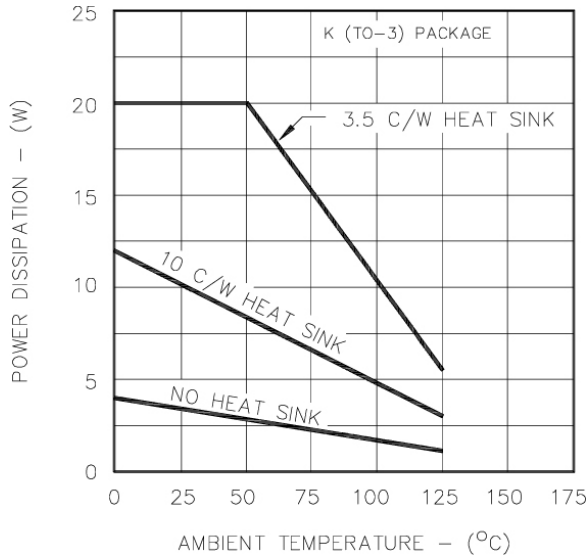
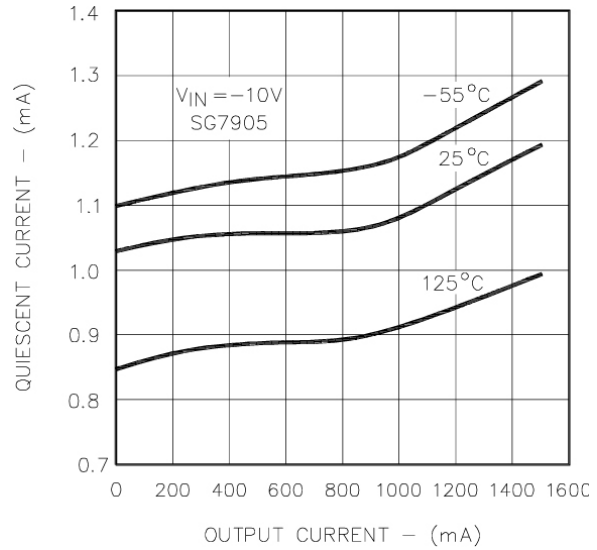
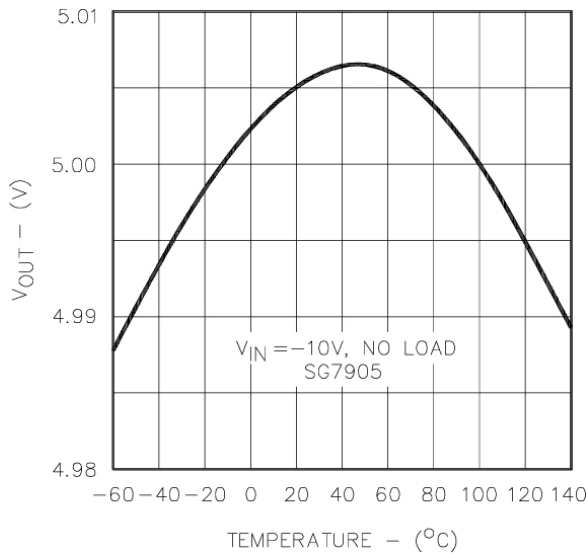
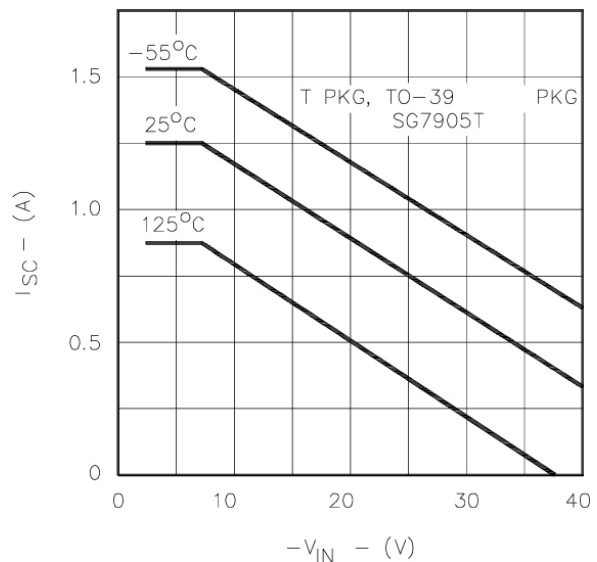
CHARACTERISTIC CURVES

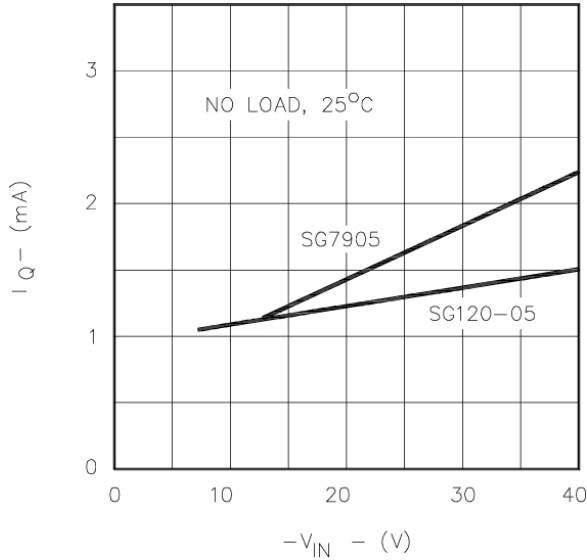
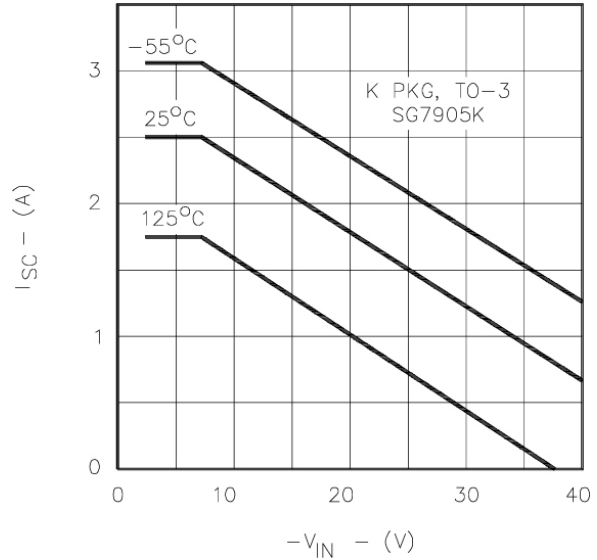
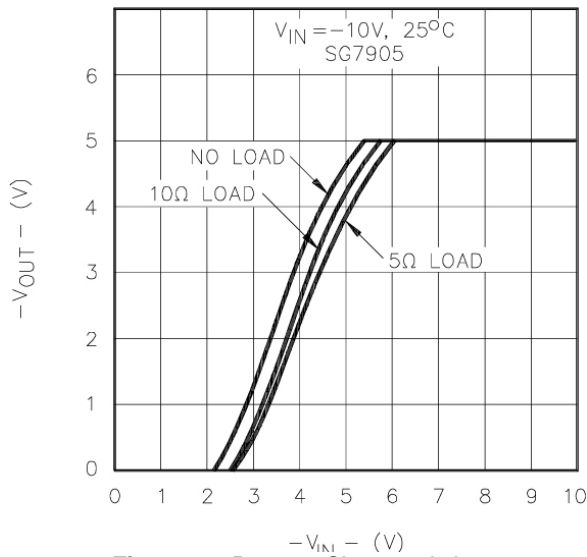
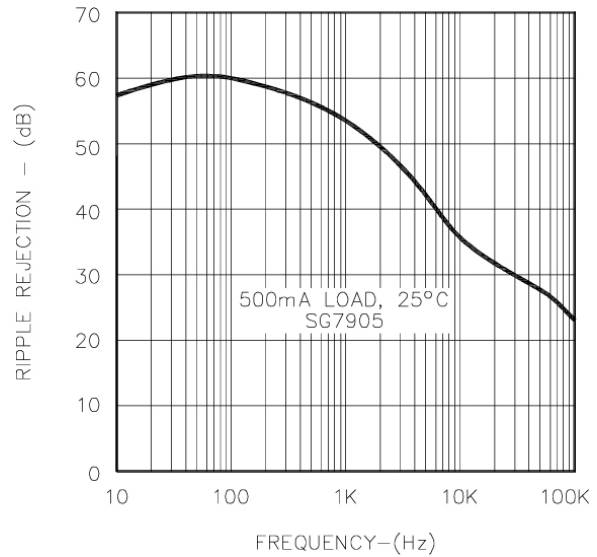
Figure 1 – Maximum Average Power Dissipation

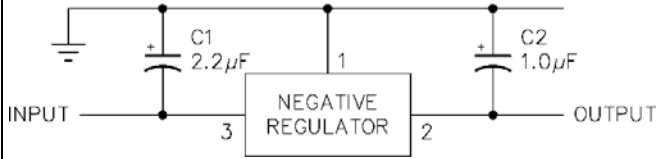
Figure 2 – Quiescent Current vs. Load

Figure 3 – Temperature Coefficient

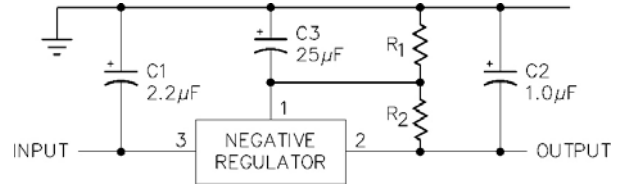
Figure 4 – Short-circuit Current vs. V_{IN}

CHARACTERISTIC CURVES

Figure 5 – Quiescent Current vs. V_{IN}

Figure 6 – Short-circuit Current Vs. V_{IN}

Figure 7 – Dropout Characteristics

Figure 8 – Ripple Rejection vs. Frequency

APPLICATIONS

Figure 9 – Fixed Output Regulator

- Note:
1. C1 is required only if regulator is separated from rectifier filter.
 2. Both C1 and C2 should be low E.S.R. types such as solid tantalum. If aluminum electrolytic capacitors are used, at least 10 times values shown should be selected.
 3. If large output capacities are used, the regulators must be protected from momentary input shorts. A high current diode.

Figure 10 – Circuit for Increasing Output Voltage

- Note: C3 optional for improved transient response and ripple rejection.

$$V_{OUT} = V(\text{REGULATOR}) \frac{R_1 + R_2}{R_1}$$

$$R_2 = \frac{V(\text{REG})}{15\text{mA}}$$

RECOMMENDED OPERATING CONDITIONS

Parameter	SG79xx / 79xxA			Units
	Min	Typ	Max	
Operating Junction Temperature Range (Note 2)	-55		150	°C

Note 2: Range over which the device is functional.

ELECTRICAL CHARACTERISTICS

Unless otherwise specified, these specifications apply over the operating ambient temperatures for SG7905A / SG7905 with $-55^{\circ}\text{C} \leq T_A \leq 125^{\circ}\text{C}$, $V_{IN} = -10\text{V}$, $I_O = 500\text{mA}$ for the K, G, and IG – Power Packages, $I_O = 100\text{mA}$ for the T and L packages, $C_{IN} = 2\mu\text{F}$, and $C_{OUT} = 1\mu\text{F}$. Low duty cycle pulse testing techniques are used which maintains junction and case temperatures equal to the ambient temperature.

Parameter	Test Conditions	SG7905A			SG7905			Units
		Min	Typ	Max	Min	Typ	Max	
Output Voltage	$T_J = 25^{\circ}\text{C}$	-4.95	-5.00	-5.08	-4.80	-5.00	-5.20	V
Line Regulation (Note 1)	$V_{IN} = -7.5\text{V to } -25\text{V}$, $T_J = 25^{\circ}\text{C}$		5	25		3	50	mV
	$V_{IN} = -8\text{V to } -12\text{V}$, $T_J = 25^{\circ}\text{C}$		3	12		1	25	mV
Load Regulation (Note 1)	Power Pkgs: $I_O = 5\text{mA to } 1.5\text{A}$, $T_J = 25^{\circ}\text{C}$		15	75		15	100	mV
	$I_O = 250\text{mA to } 750\text{mA}$, $T_J = 25^{\circ}\text{C}$		15	25		15	25	mV
	T – Pkg: $I_O = 5\text{mA to } 500\text{mA}$, $T_J = 250^{\circ}\text{C}$		5	30		5	100	mV
Total Output Voltage Tolerance	$V_{IN} = -8\text{V to } -20\text{V}$ Power Pkgs: $I_O = 5\text{mA to } 1.0\text{A}$, $P \leq 20\text{W}$ T – Pkg: $I_O = 5\text{mA to } 500\text{mA}$, $P \leq 20\text{W}$	-4.85	-5.00	-5.15	-4.70	-5.00	-5.30	V
Quiescent Current	Over Temperature Range			2.5			2.5	mA
	$T_J = 25^{\circ}\text{C}$			2.0			2.0	mA
Quiescent Current Change	With Line: $V_{IN} = -8\text{V to } -25\text{V}$			1.3			1.3	mA
	With Load: $I_O = 5\text{mA to } 1.0\text{A}$ (Power Pkgs.)			0.5			0.5	mA
	$I_O = 5\text{mA to } 500\text{mA}$ (T)			0.5			0.5	mA
Dropout Voltage	$\Delta V_O = 100\text{mV}$, $T_J = 25^{\circ}\text{C}$							
	Power Pkgs: $I_O = 1.0\text{A}$, T-Pkg: $I_O = 500\text{mA}$		1.1	2.3		1.1	2.3	V
Peak Output Current	Power Pkgs: $T_J = 25^{\circ}\text{C}$	1.5		3.3	1.5		3.3	A
	T – Pkg: $T_J = 25^{\circ}\text{C}$	0.5		1.4	0.5		1.4	A
Short Circuit Current	Power Pkgs: $V_{IN} = -35\text{V}$, $T_J = 25^{\circ}\text{C}$			1.2			1.2	A
	T – Pkg: $V_{IN} = -35\text{V}$, $T_J = 25^{\circ}\text{C}$			0.6			0.6	A
Ripple Rejection	$\Delta V_{IN} = 10\text{V}$, $f = 120\text{Hz}$, $T_J = 25^{\circ}\text{C}$	54			54			dB
Output Noise Voltage (rms)	$f = 10\text{Hz to } 100\text{kHz}$ (Note 2)		25	80		25	80	$\mu\text{V/V}$
Long Term Stability	1000 hours @ $T_J = 125^{\circ}\text{C}$		20			20		mV
Thermal Shutdown	$I_O = 5\text{mA}$		175			175		$^{\circ}\text{C}$

Note 1: All regulation tests are made at constant junction temperature with low duty cycle testing.
 2: This test is guaranteed but is not tested in production.

ELECTRICAL CHARACTERISTICS

Unless otherwise specified, these specifications apply over the operating ambient temperatures for SG7912A / SG7912 with $-55^{\circ}\text{C} \leq T_A \leq 125^{\circ}\text{C}$, $V_{IN} = -19\text{V}$, $I_O = 500\text{mA}$ for the K, G, and IG – Power Packages, $I_O = 100\text{mA}$ for the T and L packages, $C_{IN} = 2\mu\text{F}$, and $C_{OUT} = 1\mu\text{F}$. Low duty cycle pulse testing techniques are used which maintains junction and case temperatures equal to the ambient temperature.

Parameter	Test Conditions	SG7912A			SG7912			Units
		Min	Typ	Max	Min	Typ	Max	
Output Voltage	$T_J = 25^{\circ}\text{C}$	-11.8	-12.0	-12.2	-11.5	-12.0	-12.5	V
Line Regulation (Note 1)	$V_{IN} = -14.5\text{V to } -30\text{V}$, $T_J = 25^{\circ}\text{C}$		4	60		10	120	mV
	$V_{IN} = -16\text{V to } -22\text{V}$, $T_J = 25^{\circ}\text{C}$		3	30		3	60	mV
Load Regulation (Note 1)	Power Pkgs: $I_O = 5\text{mA to } 1.5\text{A}$, $T_J = 25^{\circ}\text{C}$		20	90		12	120	mV
	$I_O = 250\text{mA to } 750\text{mA}$, $T_J = 25^{\circ}\text{C}$		10	40		10	60	mV
	T – Pkg: $I_O = 5\text{mA to } 500\text{mA}$, $T_J = 25^{\circ}\text{C}$		10	40		10	240	mV
Total Output Voltage Tolerance	$V_{IN} = -14.5\text{V to } -27\text{V}$ Power Pkgs: $I_O = 5\text{mA to } 1.0\text{A}$, $P \leq 20\text{W}$ T – Pkg: $I_O = 5\text{mA to } 500\text{mA}$, $P \leq 2\text{W}$	-11.7	-12.0	-12.3	-11.4	-12.0	-12.6	V
Quiescent Current	Over Temperature Range			4			4	mA
	$T_J = 25^{\circ}\text{C}$			3			3	mA
Quiescent Current Change	With Line: $V_{IN} = -14.5\text{V to } -30\text{V}$			1.0			1.0	mA
	With Load: $I_O = 5\text{mA to } 1.0\text{A}$ (Power Pkgs.)			0.5			0.5	mA
	$I_O = 5\text{mA to } 500\text{mA}$ (T)			0.5			0.5	mA
Dropout Voltage	$\Delta V_O = 100\text{mV}$, $T_J = 25^{\circ}\text{C}$							
	Power Pkgs: $I_O = 1.0\text{A}$, T – Pkg: $I_O = 500\text{mA}$		1.1	2.3		1.1	2.3	V
Peak Output Current	Power Pkgs: $T_J = 25^{\circ}\text{C}$	1.5		3.3	1.5		3.3	A
	T – Pkg: $T_J = 25^{\circ}\text{C}$	0.5		1.4	0.5		1.4	A
Short Circuit Current	Power Pkgs: $V_{IN} = -35\text{V}$, $T_J = 25^{\circ}\text{C}$			1.2			0.2	A
	T – Pkg: $V_{IN} = -35\text{V}$, $T_J = 25^{\circ}\text{C}$			0.6			0.6	A
Ripple Rejection	$\Delta V_{IN} = 10\text{V}$, $f = 120\text{Hz}$, $T_J = 25^{\circ}\text{C}$	54			54			dB
Output Noise Voltage (rms)	$f = 10\text{Hz to } 100\text{kHz}$ (note 2)		25	80		25	80	$\mu\text{V/V}$
Long Term Stability	1000 hours @ $T_J = 125^{\circ}\text{C}$		60			60		mV
Thermal Shutdown	$I_O = 5\text{mA}$		175			175		$^{\circ}\text{C}$

Note 1: All regulation tests are made at constant junction temperature with low duty cycle testing.
 Note 2: This test is guaranteed but is not tested in production.

ELECTRICAL CHARACTERISTICS

Unless otherwise specified, these specifications apply over the operating ambient temperatures for SG7915A / SG7915 with $-55^{\circ}\text{C} \leq T_A \leq 125^{\circ}\text{C}$, $V_{IN} = -23\text{V}$, $I_O = 500\text{mA}$ for the K, G, and IG – Power Packages, $I_O = 100\text{mA}$ for the T and L packages, $C_{IN} = 2\mu\text{F}$, and $C_{OUT} = 1\mu\text{F}$. Low duty cycle pulse testing techniques are used which maintains junction and case temperatures equal to the ambient temperature.

Parameter	Test Conditions	SG7915A			SG7915			Units
		Min	Typ	Max	Min	Typ	Max	
Output Voltage	$T_J = 25^{\circ}\text{C}$	-14.8	-15.0	-15.2	-14.4	-15.0	-15.6	V
Line Regulation (Note 1)	$V_{IN} = -17.5\text{V to } -30\text{V}$, $T_J = 25^{\circ}\text{C}$		5	75		11	150	mV
	$V_{IN} = -20\text{V to } -25\text{V}$, $T_J = 25^{\circ}\text{C}$		3	40		3	75	mV
Load Regulation (Note 1)	Power Pkgs: $I_O = 5\text{mA to } 1.5\text{A}$, $T_J = 25^{\circ}\text{C}$		30	100		12	150	mV
	$I_O = 250\text{mA to } 750\text{mA}$, $T_J = 25^{\circ}\text{C}$		4	50		4	75	mV
	T – Pkg: $I_O = 5\text{mA to } 500\text{mA}$, $T_J = 25^{\circ}\text{C}$		10	50		10	240	
Total Output Voltage Tolerance	$V_{IN} = -18.5\text{V to } -30\text{V}$ Power Pkgs: $I_O = 5\text{mA to } 1.0\text{A}$, $P \leq 20\text{W}$ T – Pkg: $I_O = 5\text{mA to } 500\text{mA}$, $P \leq 2\text{W}$	-14.6	-15.0	-15.4	-14.25	-15.00	-15.75	V
Quiescent Current	Over Temperature Range			4			4	mA
	$T_J = 25^{\circ}\text{C}$			3			3	mA
Quiescent Current Change	With Line: $V_{IN} = -18.5\text{V to } -30\text{V}$			1.0			1.0	mA
	With Load: $I_O = 5\text{mA to } 1.0\text{A}$ (Power Pkgs)			0.5			0.5	mA
	$I_O = 5\text{mA to } 500\text{mA}$ (T)			0.5			0.5	mA
Dropout Voltage	$\Delta V_O = 100\text{mV}$, $T_J = 25^{\circ}\text{C}$							
	Power Pkgs: $I_O = 1.0\text{A}$, T – Pkg: $I_O = 500\text{mA}$		1.1	2.3		1.1	2.3	V
Peak Output Current	Power Pkgs: $T_J = 25^{\circ}\text{C}$	1.5		3.3	1.5		3.3	A
	T – Pkg: $T_J = 25^{\circ}\text{C}$	0.5		1.4	0.5		1.4	A
Short Circuit Current	Power Pkgs: $V_{IN} = -35\text{V}$, $T_J = 25^{\circ}\text{C}$			1.2			1.2	A
	T – Pkg: $V_{IN} = -35\text{V}$, $T_J = 25^{\circ}\text{C}$			0.6			0.6	A
Ripple Rejection	$\Delta V_{IN} = 10\text{V}$, $f = 120\text{Hz}$, $T_J = 25^{\circ}\text{C}$	54			54			dB
Output Noise Voltage (rms)	$f = 10\text{Hz to } 100\text{kHz}$ (note 2)		25	80		25	80	$\mu\text{V/V}$
Long Term Stability	1000 hours @ $T_J = 125^{\circ}\text{C}$		60			60		mV
Thermal Shutdown	$I_O = 5\text{mA}$		175			175		

Note 1: All regulation tests are made at constant junction temperature with low duty cycle testing.
 2: This test is guaranteed but is not tested in production.

NOTES

CONNECTION DIAGRAMS & ORDERING INFORMATION (SEE NOTES BELOW)

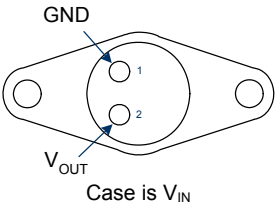
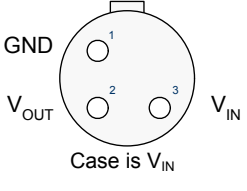
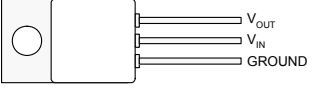
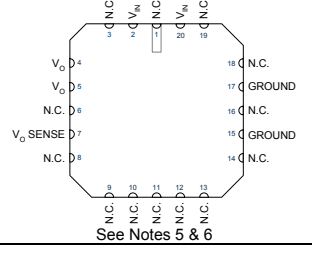
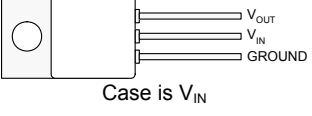
Package	Part No.	Ambient Temperature Range	Connection Diagram
3-Terminal TO-3 Metal Can K – Package	SG79xxAK/883B	-55°C to 125°C	
	SG7905AK/DESC	-55°C to 125°C	
	SG7912AK/DESC	-55°C to 125°C	
	SG7915AK/DESC	-55°C to 125°C	
	SG79xxAK	-55°C to 125°C	
	SG79xxK/883B	-55°C to 125°C	
	JAN7905K	-55°C to 125°C	
	JAN7912K	-55°C to 125°C	
3-Pin TO-39 Metal Can T – Package	SG79xxAT/883B	-55°C to 125°C	
	SG7905AT/DESC	-55°C to 125°C	
	SG7912AT/DESC	-55°C to 125°C	
	SG7915AT/DESC	-55°C to 125°C	
	SG79xxAT	-55°C to 125°C	
	SG79xxT/883B	-55°C to 125°C	
	JAN7905T	-55°C to 125°C	
	JAN7912T	-55°C to 125°C	
3-Pin Hermetic TO-257 IG – Package (Isolated)	SG79xxAIG/883B	-55°C to 125°C	
	SG7905AIG/DESC	-55°C to 125°C	
	SG7912AIG/DESC	-55°C to 125°C	
	SG7915AIG/DESC	-55°C to 125°C	
	SG79xxAIG	-55°C to 125°C	
	SG79xxIG/883B	-55°C to 125°C	
20-Pin Ceramic Leadless Chip Carrier L – Package	SG79xxL/883B	-55°C to 125°C	
	SG79xxL	-55°C to 125°C	
	SG7905AL/DESC	-55°C to 125°C	
	SG7912AL/DESC	-55°C to 125°C	
	SG7912AL/DESC	-55°C to 125°C	
3-Pin Hermetic TO-257 G – Package (Case is V _{IN})	SG79xxAG/883B	-55°C to 125°C	
	SG7905AG/DESC	-55°C to 125°C	
	SG7912AG/DESC	-55°C to 125°C	
	SG7915AG/DESC	-55°C to 125°C	
	SG79xxAG	-55°C to 125°C	
	SG79xxG/883B	-55°C to 125°C	

- Note
- 1: Contact factory for JAN and DESC product availability.
 - 2: All parts are viewed from the top.
 - 3: "xx" to be replaced by output voltage of specific fixed regulator.
 - 4: Some products will be available in hermetic flat pack (F). Consult factory for price and availability.
 - 5: Both inputs and outputs must be externally connected together at the device terminals.
 - 6: For normal operation, the V_O SENSE pin must be externally connected to the load.

PRODUCTION DATA – Information contained in this document is proprietary to Microsemi and is current as of publication date. This document may not be modified in any way without the express written consent of Microsemi. Product processing does not necessarily include testing of all parameters. Microsemi reserves the right to change the configuration and performance of the product and to discontinue product at any time.